

eternoivica

I N N O V A T I O N L E A D E R

LA POSE DU REVÊTEMENT DE SOL SURÉLEVÉ
SUR LAMBOURDE EN ALUMINIUM ET EN BOIS

FR



La pose du revêtement
de sol surélevé sur lambourde
en aluminium et en bois

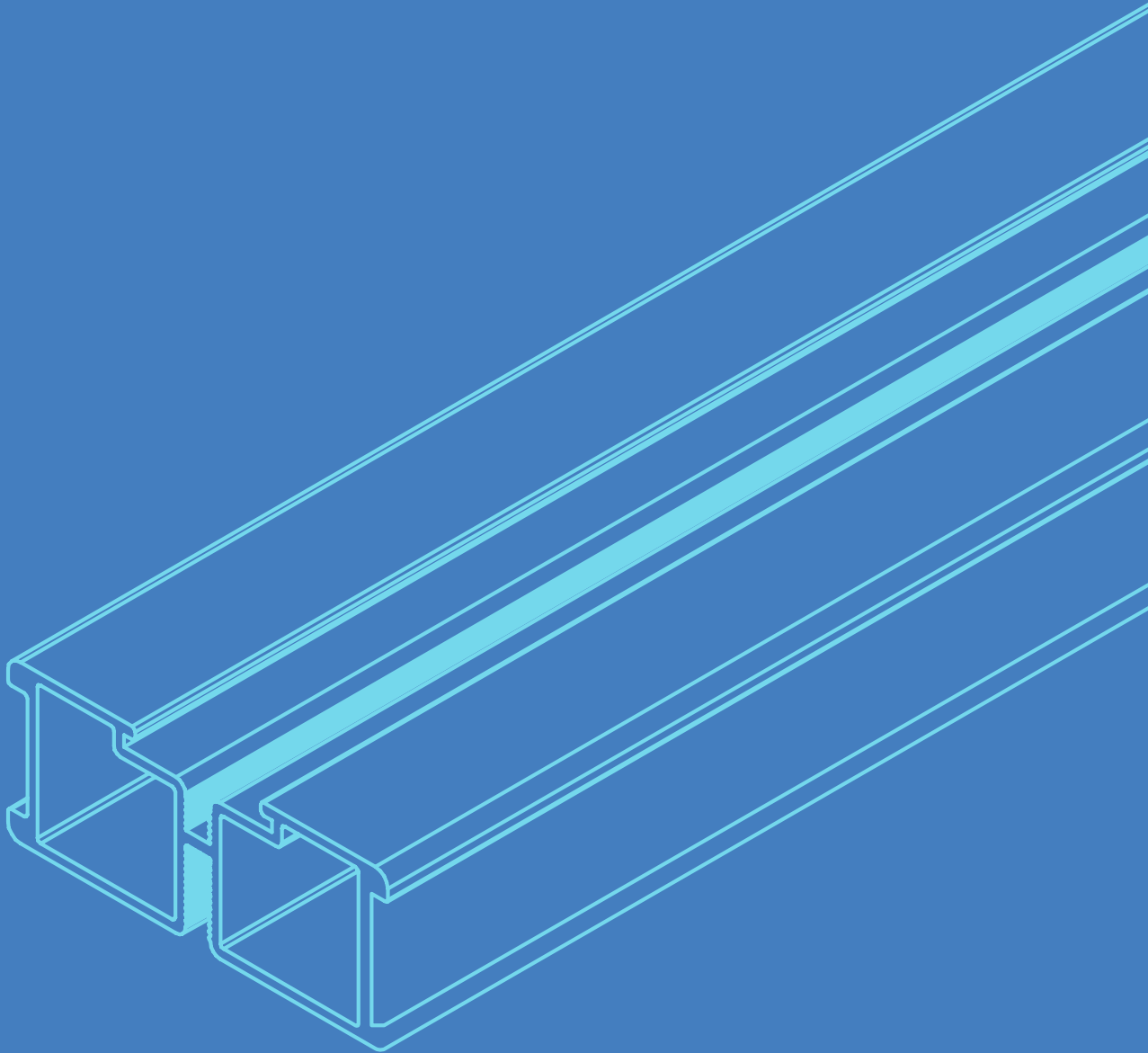

eternoivica

eternoivica

I N N O V A T I O N L E A D E R

always one step ahead



PEDESTAL



WOODECK

TABLE DES MATIÈRES

	<p>LA GAMME DES LAMBOURDES EN ALUMINIUM DE ETERNO IVICA 4</p> <p>Lambourde standard 6</p> <p>Lambourde à évacuation rapide 7</p> <p>Lambourde ECO standard 8</p> <p>Lambourde ECO à évacuation rapide 9</p>
	<p>EMPLOI DES LAMBOURDES EN ALUMINIUM 10</p>
	<p>LA GAMME DES ACCESSOIRES POUR LAMBOURDE EN ALUMINIUM DE ETERNO IVICA 12</p> <p>Compatibilité des accessoires 12</p> <p>Joint pour lambourde en aluminium standard 13</p> <p>Joint pour lambourde en aluminium à évacuation rapide, ECO standard et ECO à évacuation rapide 13</p> <p>Caoutchouc antibruit 14</p> <p>Joint en PVC 14</p> <p>Écarteur (clip) à croisillon et ailettes 4 mm H 12 mm 15</p> <p>Écarteur de périmètre 15</p> <p>Clip de tête, avec vis de fixation 16</p> <p>Clip simple 16</p> <p>Clip double 18</p> <p>Clip double avec double vis de fixation 20</p> <p>Clip bardage verticale pour pose dalles carrelage mono-format, multi-format et lattes 22</p> <p>Clip bardage verticale angulaire pour pose dalles carrelage mono-format, multi-format et lattes 23</p> <p>Clip bardage verticale pour pose lattes en bois/WPC (decking) 24</p> <p>Clip bardage verticale angulaire pour pose lattes en bois/WPC (decking) 25</p>
	<p>LA COMPATIBILITÉ DES PLOTS ETERNO IVICA AVEC LES LAMBOURDES EN ALUMINIUM 26</p>
	<p>COMMENT CALCULER LA CONSOMATION DE LAMBOURDES, PLOTS ET CLIP 30</p> <p>Pour la pose de dalles carrelage mono et multi-format 32</p> <p>Schémas de montage dalles carrelage mono et multi-format 34</p> <p>Pour la pose de lattes carrelage 36</p> <p>Schémas de montage lattes carrelage 38</p> <p>Pour la pose de lattes en bois /WPC 40</p>



LA GAMMA DES LAMBOURDES EN ALUMINIUM DE ETERNO IVICA



LAMBOURDE STANDARD

CÔTÉ A

Indiqué pour la pose de dalles carrelage auto-portantes mono et multiformat ou lattes carrelage et bois (decking) avec clip rapide Eterno Ivica.

INDIQUÉ POUR:

- Dalles carrelage mono-format
- Dalles carrelage multi-format
- Lattes carrelage
- Lattes en bois/WPC

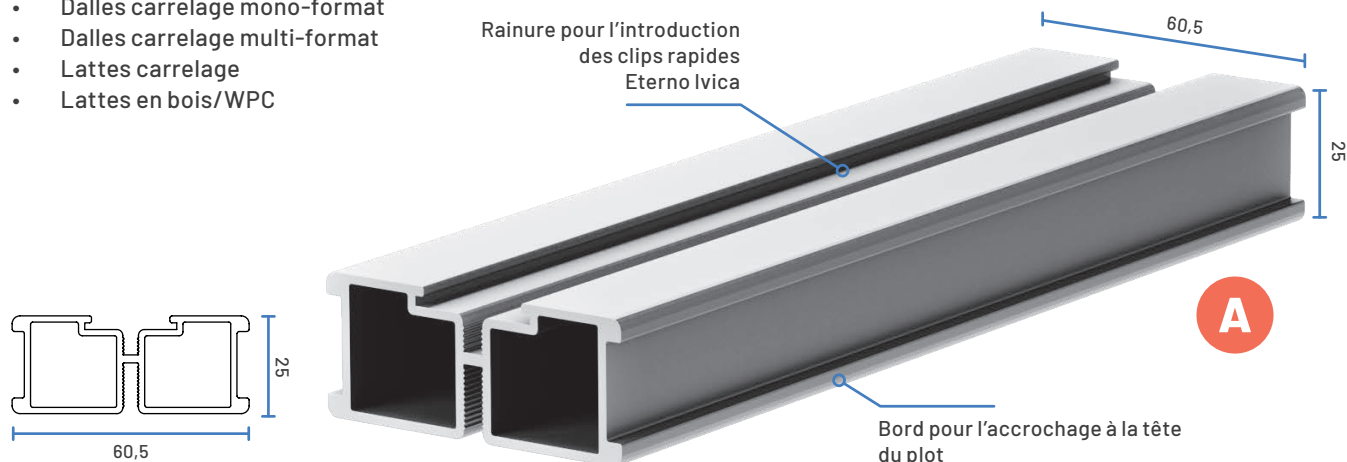

CÔTÉ B

Indiqué pour la pose de lattes en bois (decking) avec clip et vis de fixation.

INDIQUÉ POUR:

- Lattes en bois/WPC



REVERSIBLE
180°

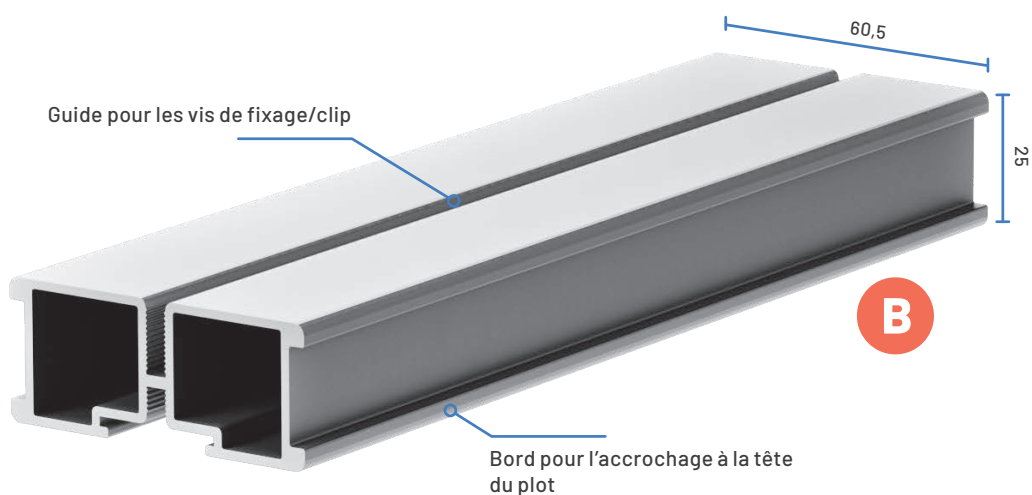

ALUMINIUM
NATUREL

TYPE	CODE	COULEUR	DIMENSION	MT
Standard	Q231020025	Aluminium naturel	Section 60 x 25 mm L 2000 mm	192

LAMBOURDE À ÉVACUATION RAPIDE

La lambourde à évacuation rapide est indiquée pour la pose de dalles carrelage auto-portantes mono et multi-format ou lattes carrelage et bois (decking) avec clip rapide Eterno Ivica

INDIQUÉ POUR:

- Dalles carrelage mono-format
- Dalles carrelage multi-format
- Lattes carrelage
- Lattes en bois/WPC

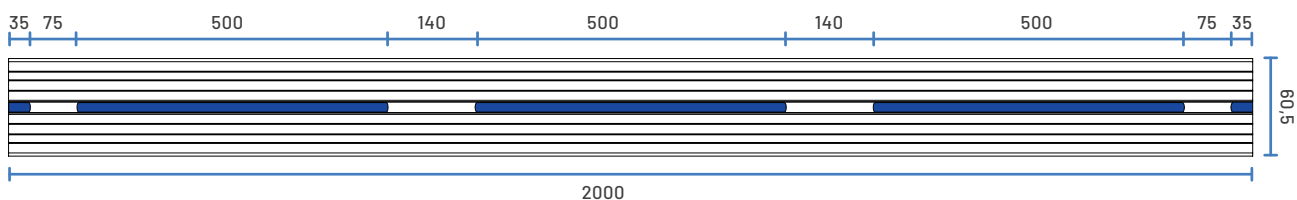
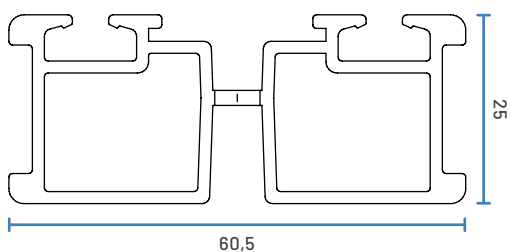
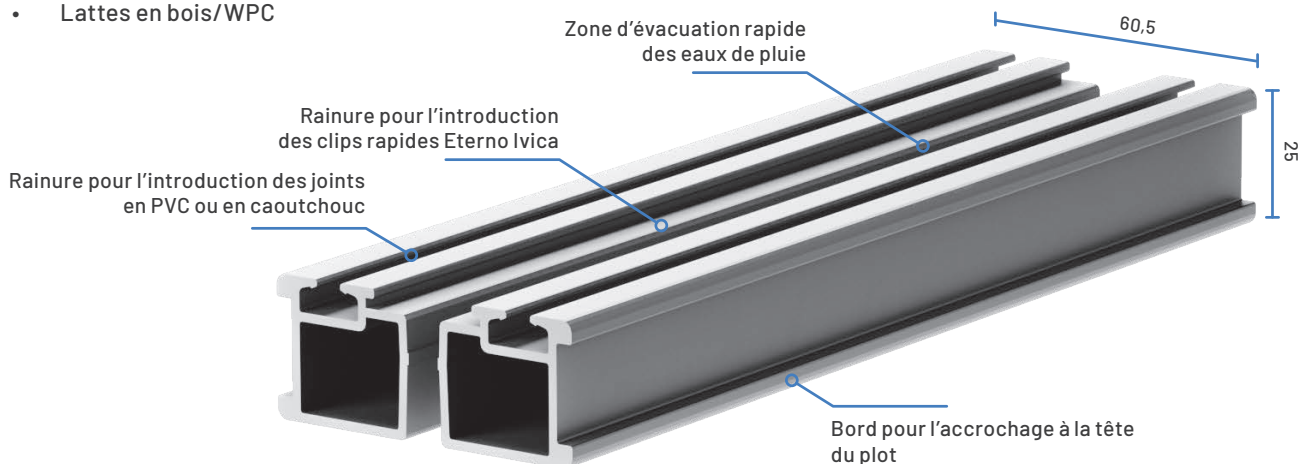

TYPE	CODE	COULEUR	DIMENSION	MT 
Évacuation rapide	Q231420026	Aluminium naturel	Section 60 x 25 mm L 2000 mm	192

LAMBOURDE ECO STANDARD

CÔTÉ A

Indiqué pour la pose de dalles carrelage auto-portantes mono et multiformat ou lattes carrelage et bois (decking) avec clip rapide Eterno Ivica.

INDIQUÉ POUR:

- Dalles carrelage mono-format
- Dalles carrelage multi-format
- Lattes carrelage
- Lattes en bois/WPC

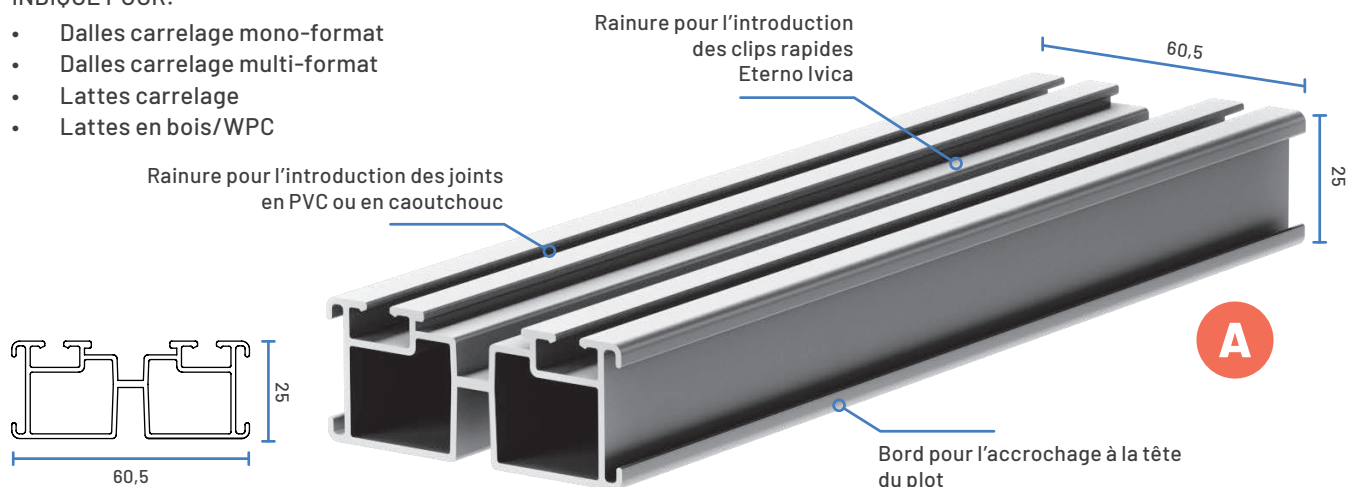

CÔTÉ B

Indiqué pour la pose de lattes en bois (decking) avec clip et vis de fixation.

INDIQUÉ POUR:

- Lattes en bois/WPC



REVERSIBLE
180°

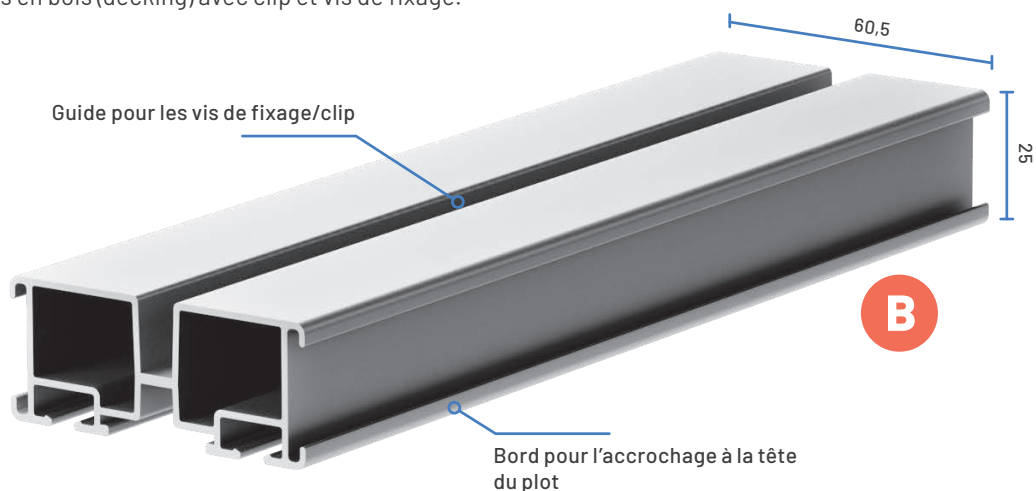

ALUMINIUM
NATUREL



NOIR

TYPE	CODE	COULEUR	DIMENSION	MT 
ECO standard	Q231020020	Aluminium naturel	Section 60 x 25 mm L 2000 mm	192
	Q231020020.N	Noir		

LAMBOURDE ECO À ÉVACUATION RAPIDE

La lambourde à évacuation rapide est indiquée pour la pose de dalles carrelage auto-portantes mono et multi-format ou lattes carrelage et bois (decking) avec clip rapide Eterno Ivica

INDIQUÉ POUR:

- Dalles carrelage mono-format
- Dalles carrelage multi-format
- Lattes carrelage
- Lattes en bois/WPC

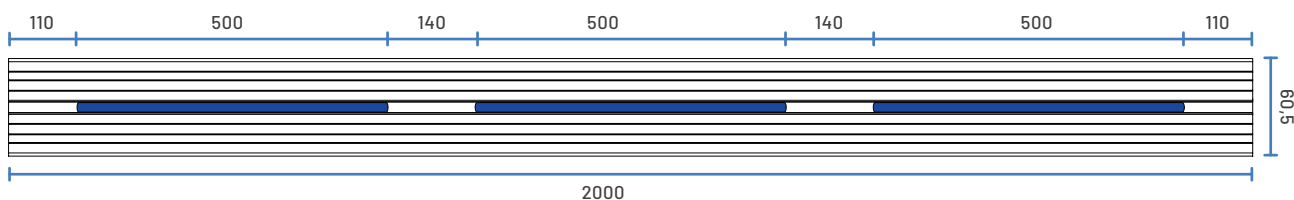
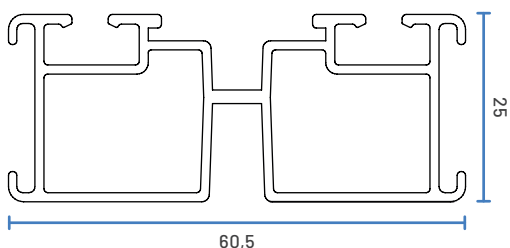
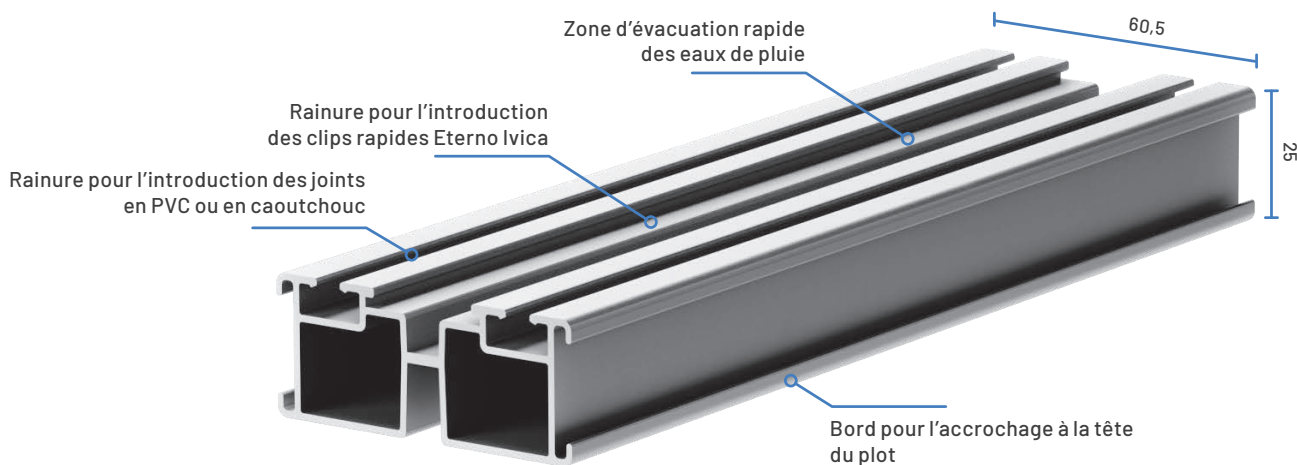

TYPE	CODE	COULEUR	DIMENSION	MT 
ECO à évacuation rapide	Q231020021	Aluminium naturel	Section 60 x 25 mm L 2000 mm	192
	Q231020021.N	Noir		

EMPLOI DES LAMBOURDES EN ALUMINIUM



CODE	DESCRIPTION	DALLES	DECKING
		Dalles carrelage/ciment/ Dalles carrelage multi-format	Lattes en bois Lattes en WPC Lattes carrelage
Q231020025	Lambourde standard	✓	✓
Q231420026	Lambourde à évacuation rapide	✓ Conseillé	✓
Q231020020 Q231020020.N	Lambourde ECO standard	✓	✓
Q231020021 Q231020021.N	Lambourde ECO à évacuation rapide	✓ Conseillé	✓

CODE	DESCRIPTION	PIÉTINEMENT ÉLEVÉ			PIÉTINEMENT MOYEN/BAS		
		Bâtiments hôtellerie et restauration Bords de piscines publiques Centres directionnels et commerciaux Toits plats et terrasses publiques Zones extérieures de bars et restaurants Passages piétonniers publics			Immeubles Bords piscines privées Toits plats et terrasses privées Passages piétonniers privés		
		Entraxe plots			Entraxe plots		
		40 cm	50 cm	66,6 cm	40 cm	50 cm	66,6 cm
Q231020025	Lambourde standard	✓	✓	✓	✓	✓	✓
Q231420026	Lambourde à évacuation rapide	✓	✓	✓	✓	✓	✓
Q231020020 Q231020020.N	Lambourde ECO standard	✓	✓	✗	✓	✓	✗
Q231020021 Q231020021.N	Lambourde ECO à évacuation rapide	✓	✓	✗	✓	✓	✗

Association Plots – Lambourde – Typologie de pose

TYPE PLOT	Pose dalles carrelage multi-format Pose dalles carrelage mono-format Pose lattes carrelage		Pose lattes en bois	
	Lambourde aluminium	Lambourde bois	Lambourde aluminium	Lambourde bois/WPC
PRIME®	✓	✗	✓	✓
REVERSUS®	✓	✗	✓	✓
SE	✓	✗	✓	✓
NM	✓	✗	✓	✓
SB	✓	✗	✓	✓
Star.T	✓	✗	✓	✓

LA GAMME DES ACCESSOIRES POUR LAMBOURDE EN ALUMINIUM DE ETERNO IVICA

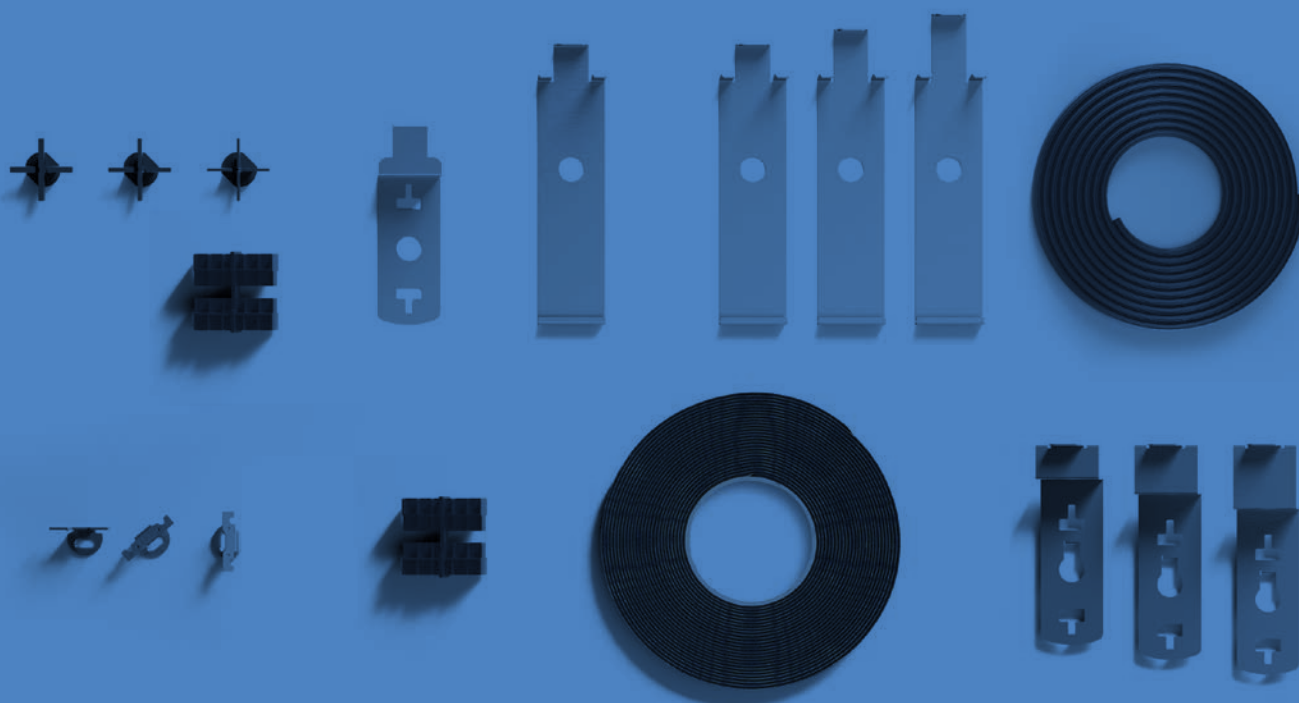

Compatibilité accessoires

LAMBOURDE	CAOUT-CHOUC ANTI-BRUIT (V13052100)	JOINT EN PVC (V13052200) (V13052205)	JOINT STANDARD (Q200000025)	JOINT À ÉVACUATION RAPIDE (Q200000026)	ÉCARTEUR (CLIP) À CROISILLON (E004000104)	CLIP DE TÊTE (Q200000240)	CLIP SIMPLE POUR DECKING 110° (Q200000231) 90° (Q200000232)	CLIP DOUBLE POUR DECKING 110° (Q200000265) 90° (Q200000260) 90° (Q200000261)	CLIP DOUBLE AVEC DOUBLE FIS DE FIXAGE (Q200000008)
Lambourde standard	✓	✗	✓	✗	✓	✓	✓	✓	✓
Lambourde à évacuation rapide	✓	✓	✗	✓	✓	✓	✓	✓	✗
Lambourde ECO standard	✓	✓	✗	✓	✓	✓	✓	✓	✓
Lambourde ECO à évacuation rapide	✓	✓	✗	✓	✓	✓	✓	✓	✗

JOINT POUR LAMBOURDE EN ALUMINIUM STANDARD

COMPATIBLE AVEC:

- Lambourde en aluminium standard

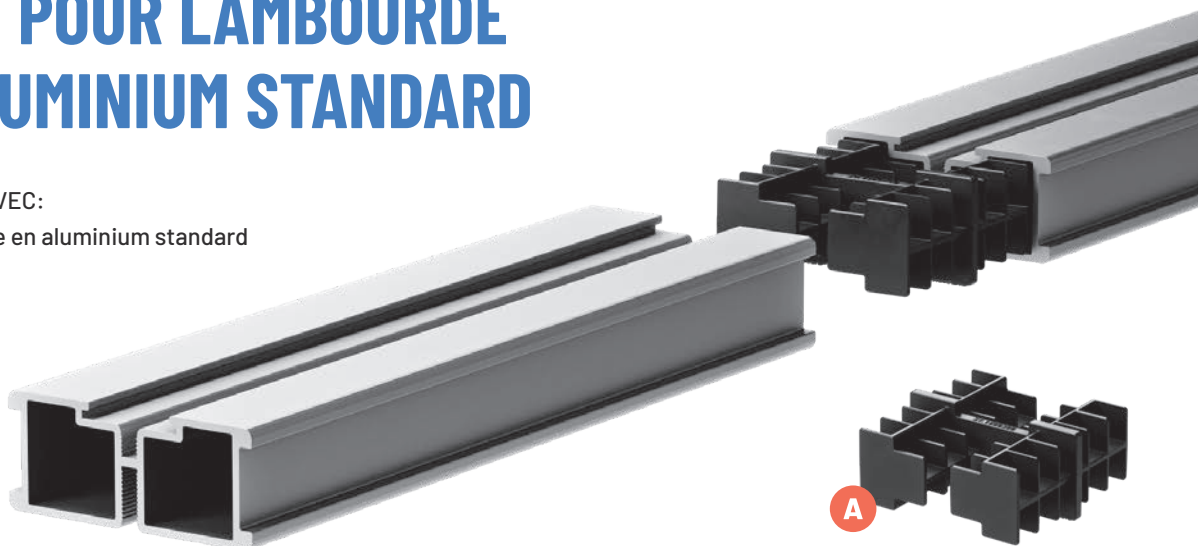

JOINT POUR LAMBOURDE EN ALUMINIUM À ÉVACUATION RAPIDE, ECO STANDARD ET ECO À ÉVACUATION RAPIDE

COMPATIBLE AVEC:

- Lambourde en aluminium à évacuation rapide
- Lambourde en aluminium ECO standard
- Lambourde en aluminium ECO à évacuation rapide

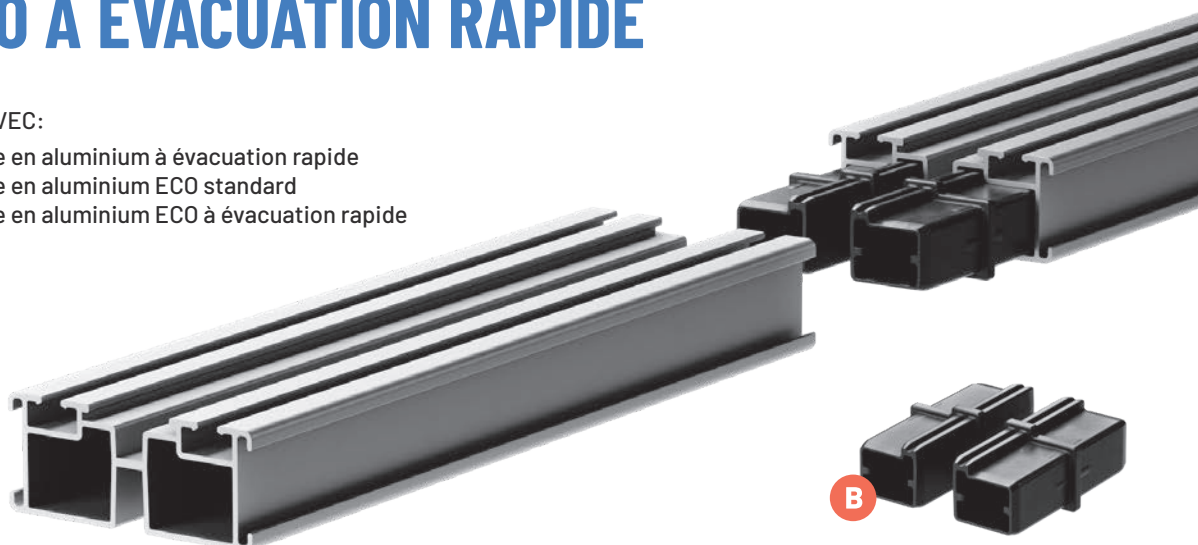

CODE	TYPE	DESCRIPTION	COMPATIBILITÉ LAMBOURDE	PIÈCES 
Q200000025	A	Joint de raccord	Standard	200
Q200000026	B	Joint de raccord	Évacuation rapide ECO standard ECO évacuation rapide	200

CAOUTCHOUC ANTIBRUIT

COMPATIBLE AVEC:

- Lambourde en aluminium standard
- Lambourde en aluminium à évacuation rapide
- Lambourde en aluminium ECO standard
- Lambourde en aluminium ECO à évacuation rapide

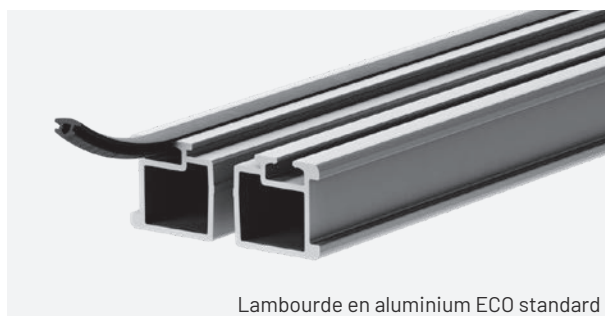
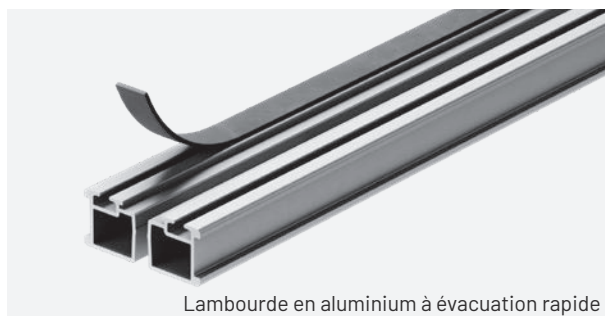

JOINT EN PVC

COMPATIBLE AVEC:

- Lambourde en aluminium à évacuation rapide
- Lambourde en aluminium ECO standard
- Lambourde en aluminium ECO à évacuation rapide



COCE	TYPE	DESCRIPTION	COMPATIBILITÉ LAMBOURDE	PIÈCES 
V13052100	A	Caoutchouc antibruit	Standard Évacuation rapide ECO standard ECO évacuation rapide	Rouleau 10 mt
V13052205	B	Joint en PVC	Évacuation rapide ECO standard ECO évacuation rapide	Rouleau 50 mt
V13052200	B	Joint en PVC		Rouleau 200 mt

ÉCARTEUR (CLIP) À CROISILLON À AILETTES 4 MM H 12 MM



INDIQUÉ POUR:

- Dalles carrelage mono-format
- Dalles carrelage multi-format
- Lattes carrelage



Attache rapide
NON vis

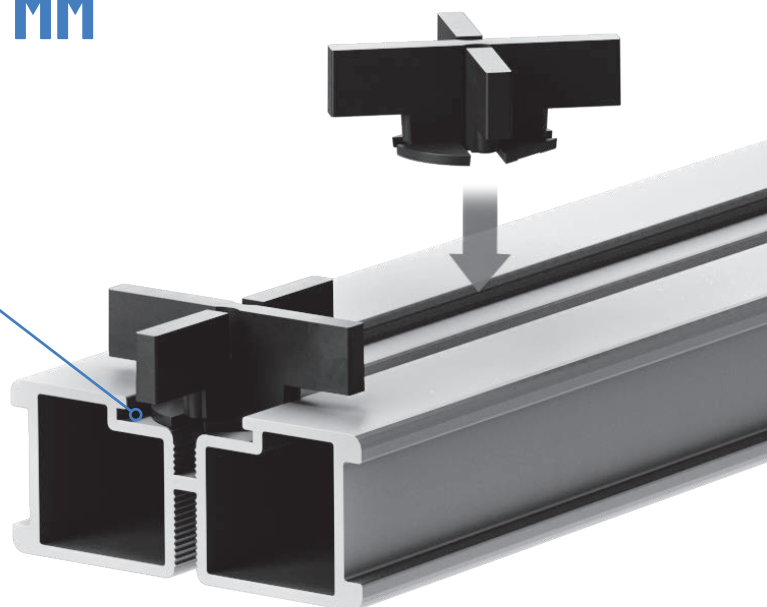

Écarteur (clip) à croisillon à ailettes 4 mm h 12 mm

CODE	TYPE	DIMENSION	PIÈCES
E004000104	Ecarteur (clip) à croisillon à ailettes 4 mm h 12 mm *	42 x 42 mm	1000**

* Ailettes épaisseur 2 ou 3 mm disponibles sur demande.

** À l'intérieur des boîtes il y a 2 confections de 500 pièces.

ÉCARTEUR DE PÉRIMÈTRE

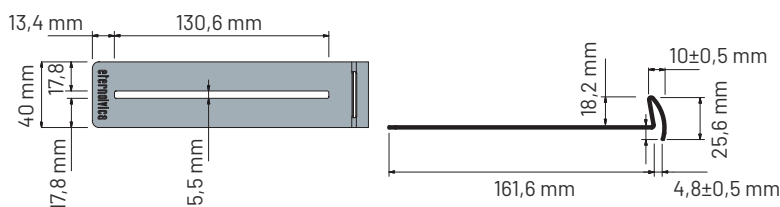

CODE	DESCRIPTION	MATÉRIEL	HAUTEUR	LONGUEURS	PIÈCES
P021000220	Écarteur de périmètre	Acier inox	25,6 mm	161,6 mm	100
P021000230	Écarteur de périmètre	Polypropylène PP	25,6 mm	161,6 mm	200

CLIP DE TÊTE, AVEC VIS DE FIXAGE

INDIQUÉ POUR:

- Dalles carrelage mono-format
- Dalles carrelage multi-format
- Lattes carrelage

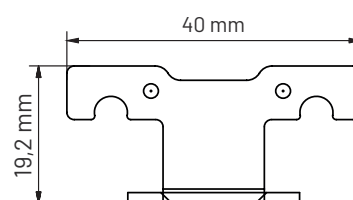
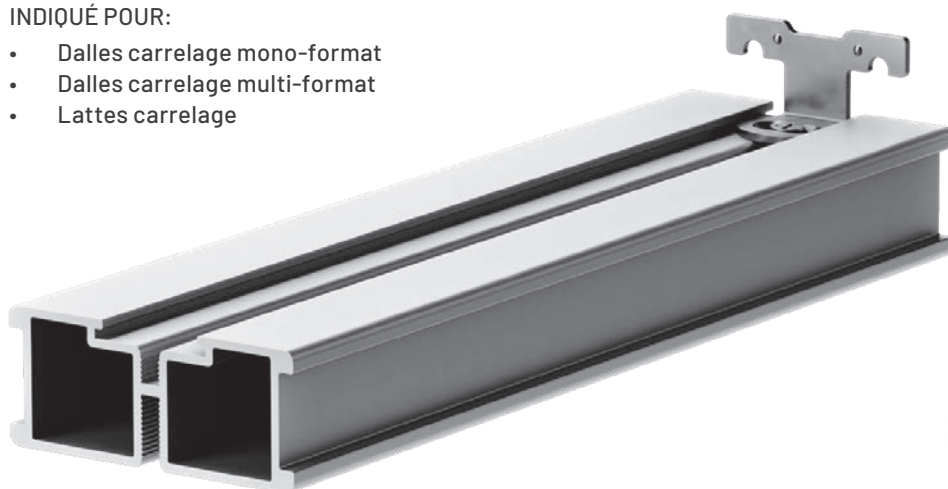

CODE	TYPE	DIMENSION	PIÈCES*
Q200000240	Clip de tête	H 19,2 mm	1

* La clip de tête comprend la relative vis de fixation diamètre 3,9 mm – L 19 mm.

CLIP SIMPLE

INDIQUÉ POUR:

- Lattes en bois/WPC (decking)

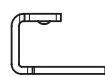

N. 1 clip simple 90°

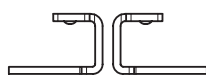

N. 2 clips simples 90°

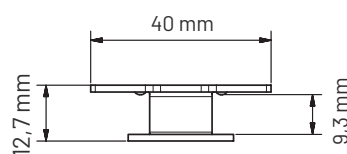

90°



N. 1 clip simple 110°

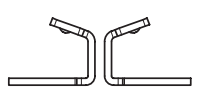

N. 2 clips simples 110°

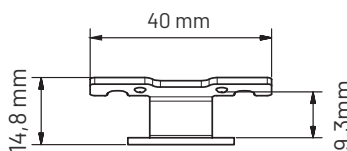

110°

CODE	TYPE	DIMENSION	PIÈCES* 
Q200000232	Clip simple 90°	H 12,7 mm	50
Q200000231	Clip simple 110°	H 14,8 mm	50

* Les confections de 50 clips comprennent 25 vis de fixation diamètre 3,9 mm – L 19 mm.

COTE POUR LEVE-DALLE



CLIP SIMPLE 90° (Q200000232)

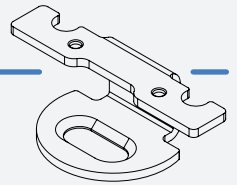

Côté supérieur dalle

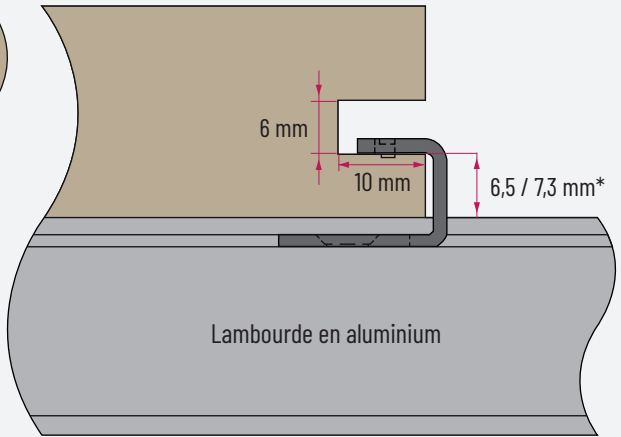
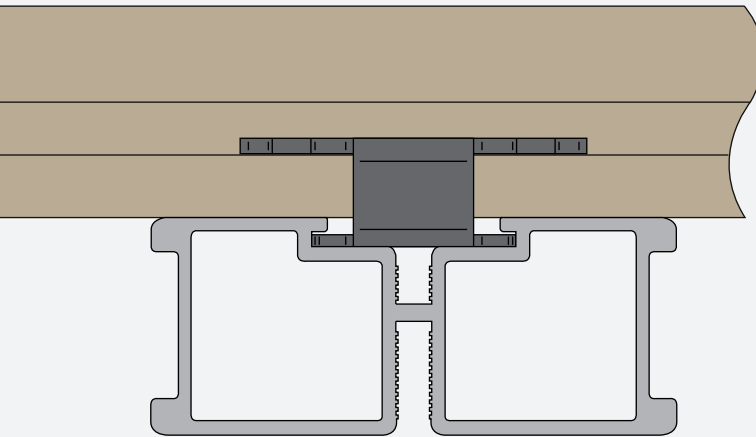

*6,6 mm si la dalle est posée sur le caoutchouc anti-bruit ou un joint en PVC
7,3 mm si la dalle est posée directement en contact avec l'aluminium.

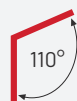

CLIP SIMPLE 110° (Q200000231)

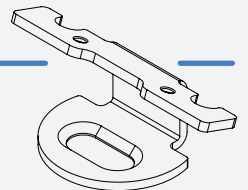

Côté supérieur dalle

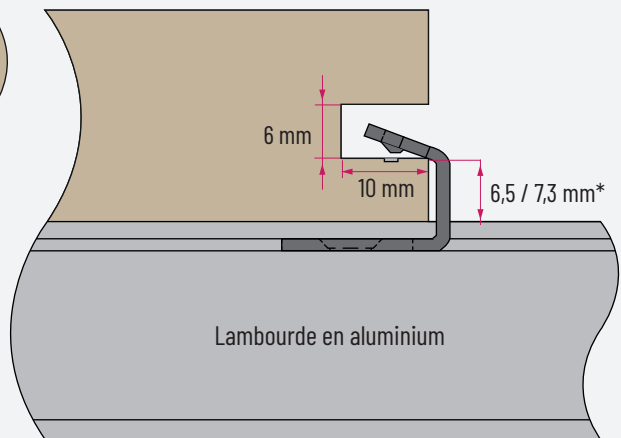
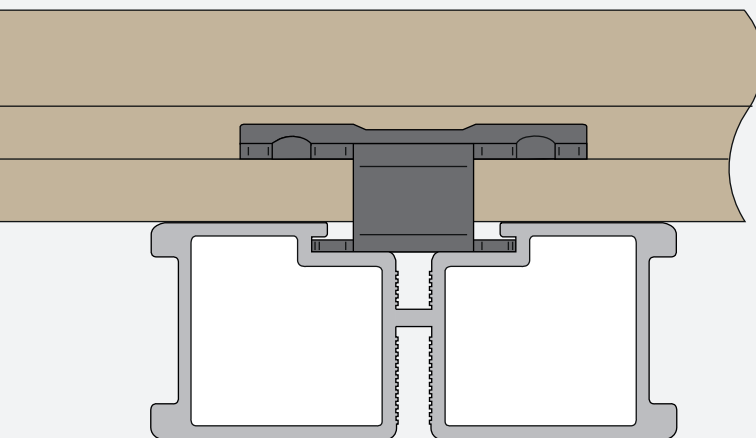



*6,6 mm si la dalle est posée sur le caoutchouc anti-bruit ou un joint en PVC
7,3 mm si la dalle est posée directement en contact avec l'aluminium.

CLIP DOUBLE

INDIQUÉ POUR:

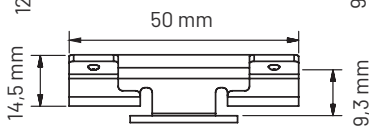
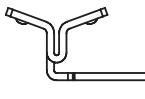
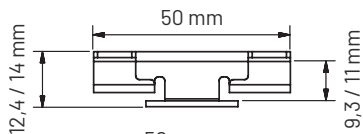
- Lattes en bois/WPC (decking)



CODE	TYPE	DIMENSION	PIÈCES* 
Q200000260	Clip double 90°	50 x 26 x 12,4 mm	100
Q200000261	Clip double 90°	50 x 26 x 14,0 mm	100
Q200000265	Clip double 110°	50 x 26 x 14,5 mm	100

* Les confections de 100 clips comprennent 25 vis de fixation diamètre 3,9 mm - L 19 mm.

COTE POUR LEVE-DALLE

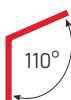

CLIP DOUBLE 110° (Q200000265)

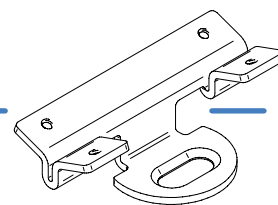

Côté supérieur dalle

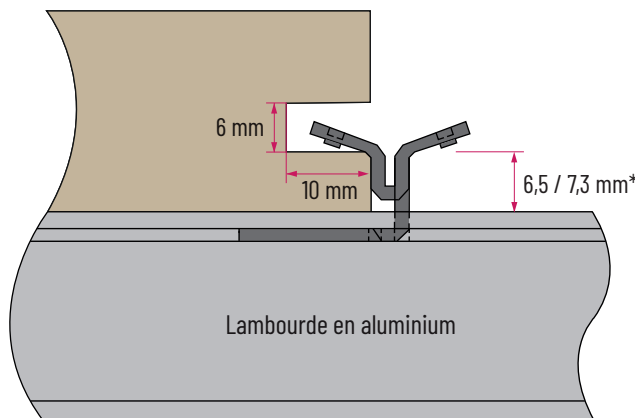
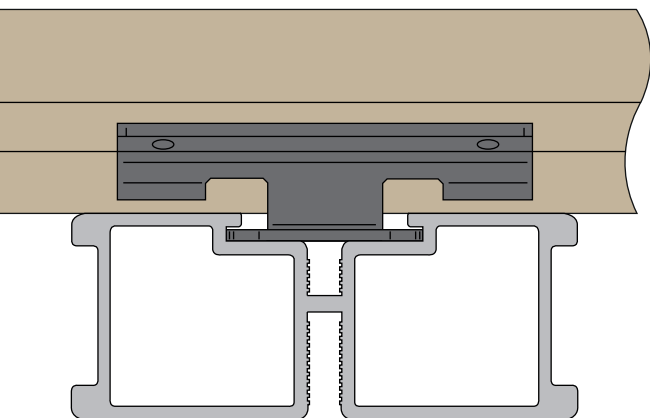

* 6,6 mm si la dalle est posée sur le caoutchouc anti-bruit ou un joint en PVC
7,3 mm si la dalle est posée directement en contact avec l'aluminium.

COTE POUR LEVE-DALLE



CLIP DOUBLE 90° (Q200000260)

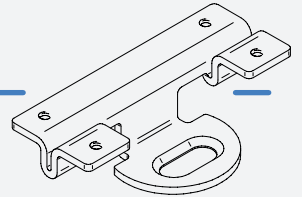

Côté supérieur dalle

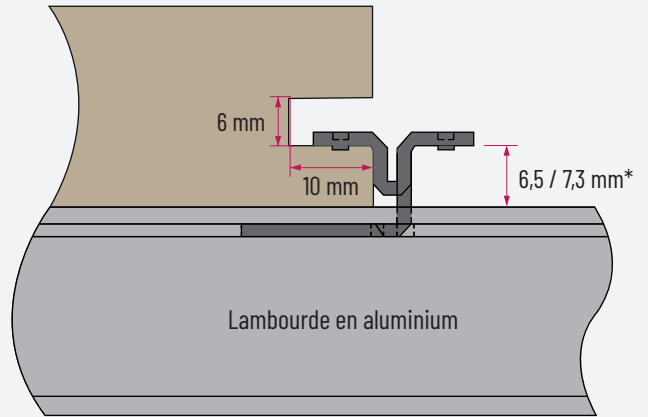
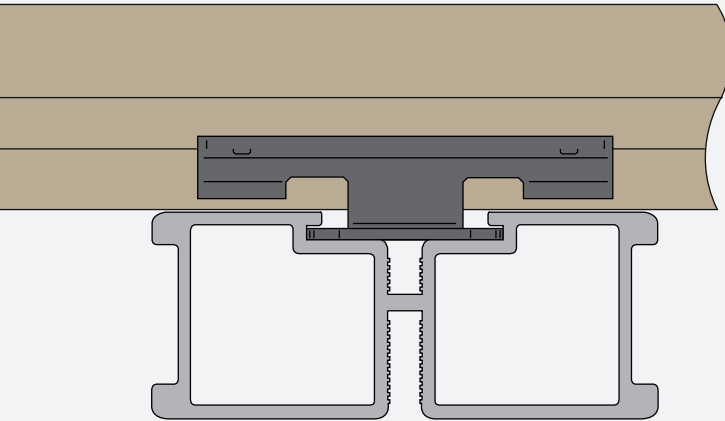

*6,6 mm si la dalle est posée sur le caoutchouc anti-bruit ou un joint en PVC
7,3 mm si la dalle est posée directement en contact avec l'aluminium.



CLIP DOUBLE 90° (Q200000261)

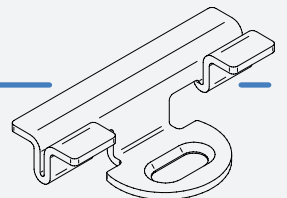

Côté supérieur dalle

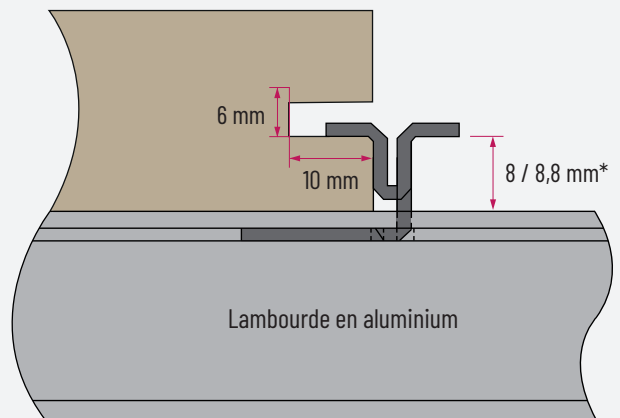
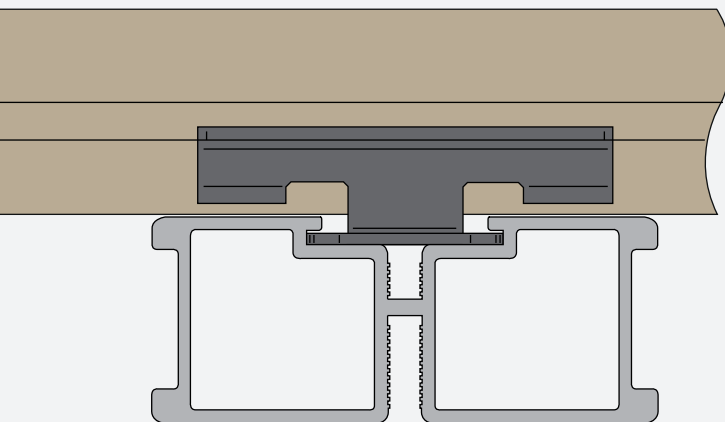

*8 mm si la dalle est posée sur le caoutchouc anti-bruit ou un joint en PVC
8,8 mm si la dalle est posée directement en contact avec l'aluminium.

CLIP DOUBLE, RAPIDE AVEC VIS DE FIXAGE

INDIQUÉ POUR:

- Lattes en bois/WPC (decking)

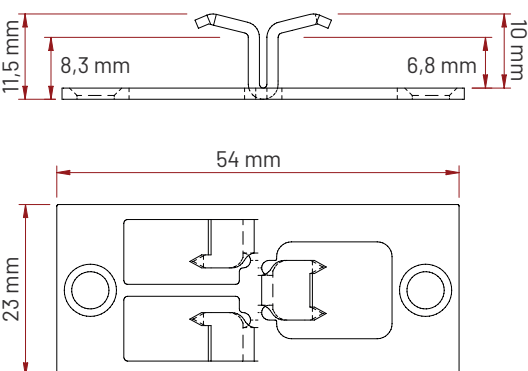
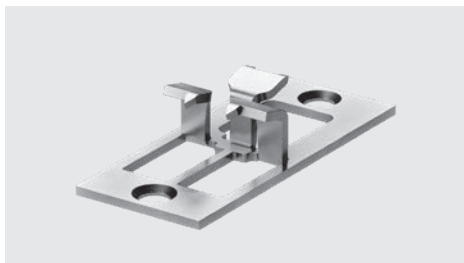

A

Côté A de la lamourde standard et ECO standard

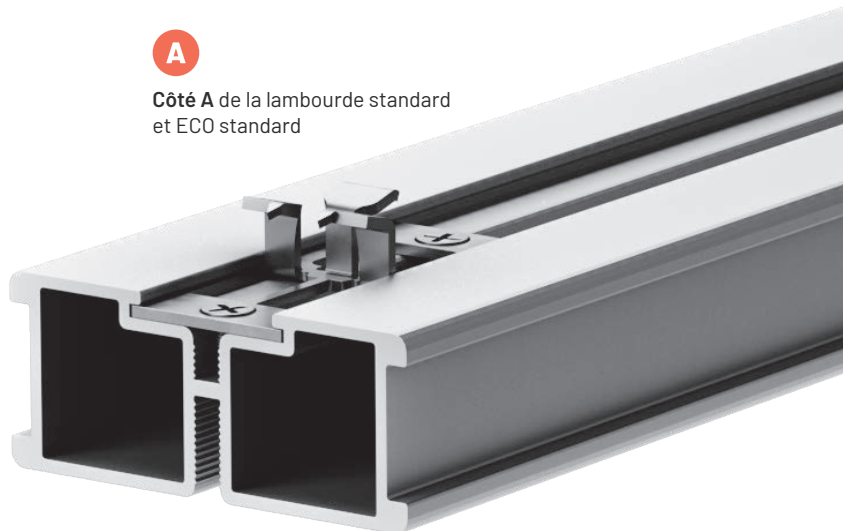

B

Côté B de la lamourde standard et ECO standard

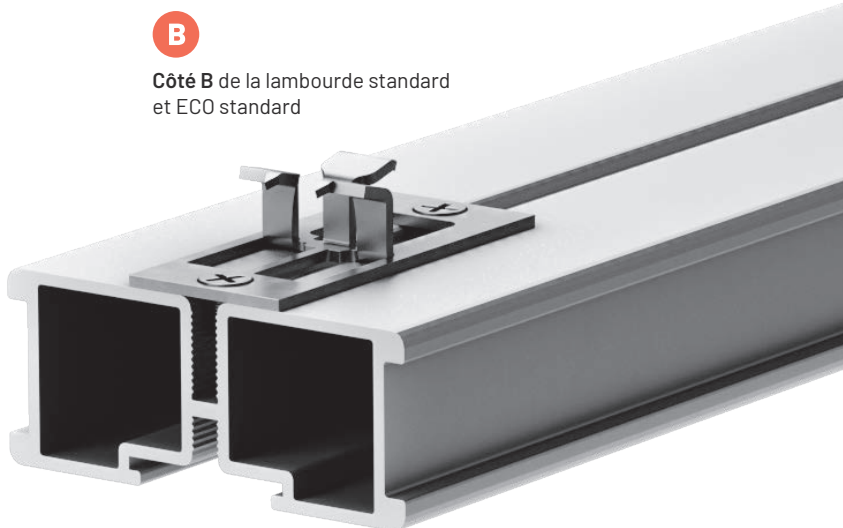

CODE	TYPE	DIMENSION	PIÈCES* 
Q200000008	Clip double avec vis de fixation	54 x 23 x 11,5 mm	100

* Les confections de 100 clips comprennent 200 vis de fixation diamètre 2,9 mm - L 22 mm.

COTE POUR LEVE-DALLE

CLIP DOUBLE A DOUBLE VIS DE FIXAGE (Q200000008)

Lambourde côté A (clip introduite dans la lève-dalle)

Côté supérieur dalle

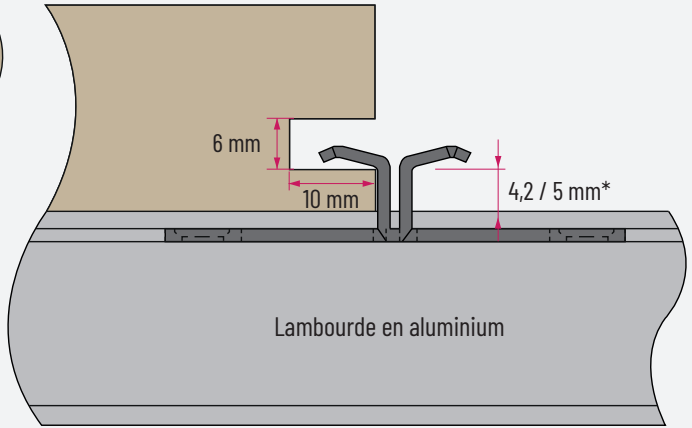
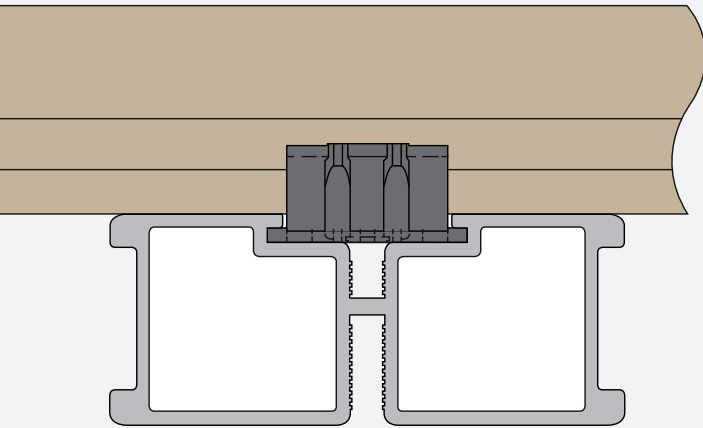
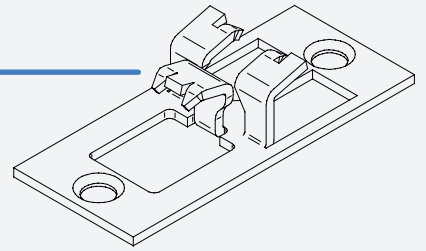

* 4,2 mm si la dalle est posée sur le caoutchouc anti-bruit ou un joint en PVC
5 mm si la dalle est posée directement en contact avec l'aluminium.

CLIP DOUBLE A DOUBLE VIS DE FIXAGE (Q200000008)

Lambourde côté B (clip en appui)

Côté supérieur dalle

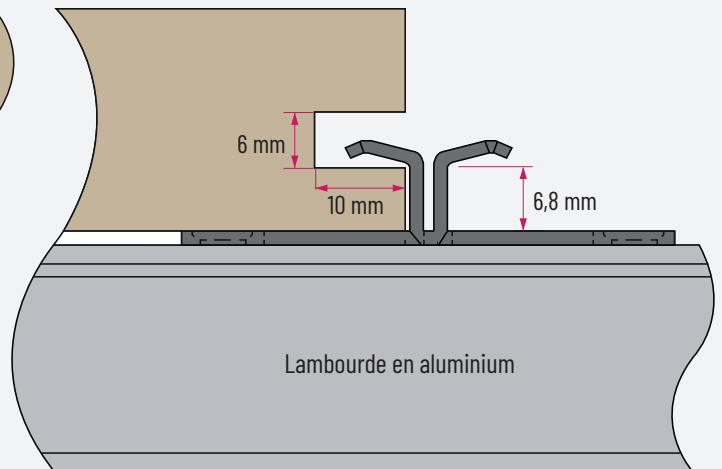
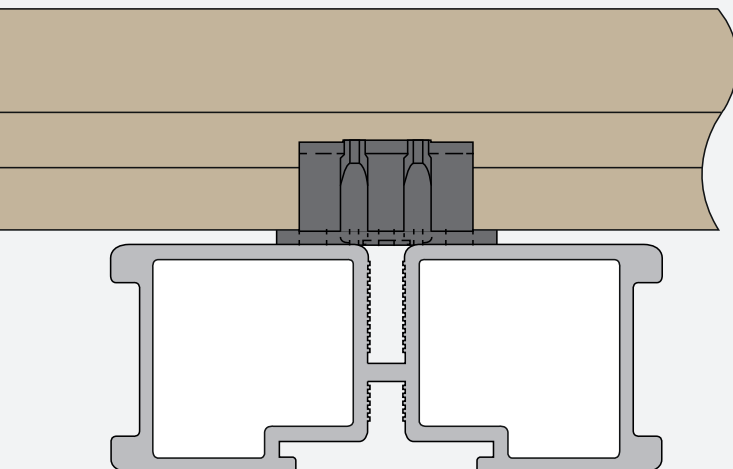

CLIP BARDAGE VERTICAL POUR POSE DALLES CARRELAGE MONO-FORMAT, MULTI-FORMAT ET LATTES CARRELAGE

INDIQUÉ POUR:

- Dalles carrelage mono-format
- Dalles carrelage multi-format
- Lattes carrelage



Clip de bardage vertical tête

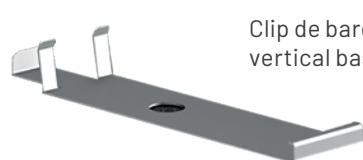

Clip de bardage vertical base

CODE	DESCRIPTION	COMPATIBILITÉ PLOTS	Ø TÊTE PLOTS	ÉPAISSEUR	PIÈCES 
P021000722	Clip tête	SRT - SE - NM - SB	110 mm	20 mm	100
		SRT	150 mm		
P021000822	Clip tête	PR - NM avec base à rupture facilitée	110 mm	20 mm	100
P021000322	Clip base	PR - SRT -SE - NM - SB	110 mm	20 mm	100
		SRT	150 mm		

CLIP BARDAGE ANGULAIRE POUR POSE DALLES CARRELAGE MONO-FORMAT, MULTI-FORMAT ET LATTES CARRELAGE

INDIQUÉ POUR:

- Dalles carrelage mono-format
- Dalles carrelage multi-format
- Lattes carrelage



Tête

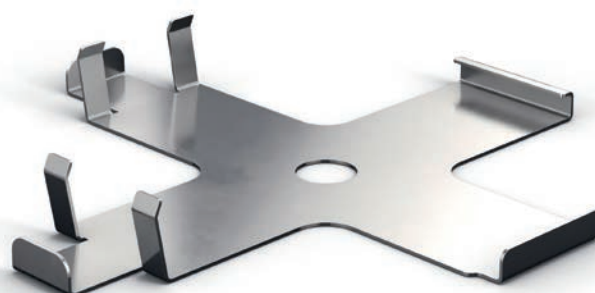

Base

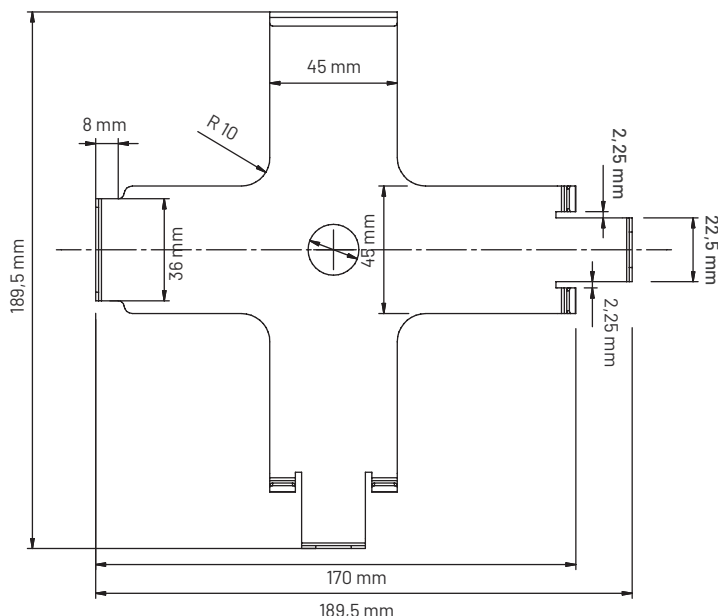
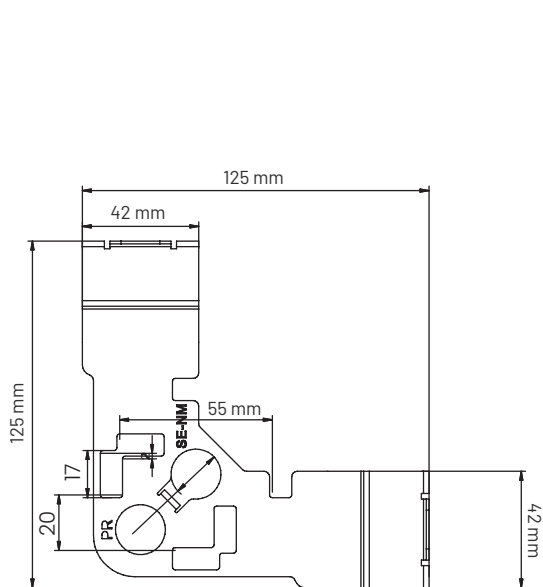

CODE	DESCRIPTION	COMPATIBILITÉ PLOTS	Ø TÊTE PLOTS	ÉPAISSEUR	PIÈCES 
P021000952	Clip tête	PR - SE - NM - SB	110mm	20mm	25
P021000952.N	Clip tête	SRT	110 - 150 mm	20 mm	25
P021000912	Clip base	PR - SRT - SE - NM - SB	110mm	20 mm	25
		SRT	150 mm		

CLIP BARDAGE VERTICAL POUR POSE LATTES EN BOIS/WPC (DECKING)

INDIQUÉ POUR:

- Lattes en bois (decking)

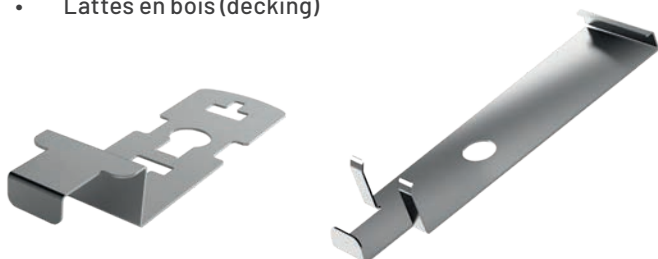

Clip de bardage vertical tête

Clip de bardage vertical base

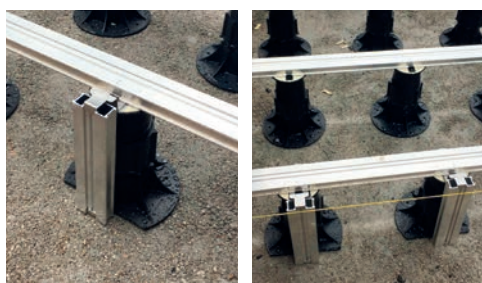

- 1 Revêtement sol en bois ou autre matériel
- 2 Lambourde en aluminium
- 3 Clip de tête pour bardage vertical
- 4 Clip base pour bardage vertical
- 5 Clip pour lambourde en aluminium



CODE	DESCRIPTION	COMPATIBILITÉ PLOTS	Ø TÊTE PLOTS	ÉPAISSEUR	PIÈCES 
P021000430	Clip tête	SE - NM - SB	110 mm	20 mm	100
P021000430.N	Clip tête	SRT	110 - 150 mm	20 mm	100
P021000432	Clip tête	PR - NM avec base à rupture facilitée	110 mm	20 mm	100
P021000322	Clip base	PR-SRT-SE-NM-SB	110 mm	20 mm	100
		SRT	150 mm		

CLIP BARDAGE VERTICAL ANGULAIRE POUR POSE LATTES EN BOIS/WPC (DECKING)

INDIQUÉ POUR:

- Lattes en bois/WPC (decking)

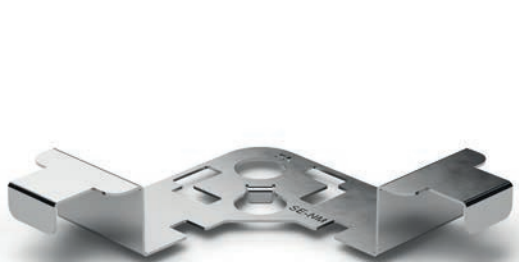

Tête

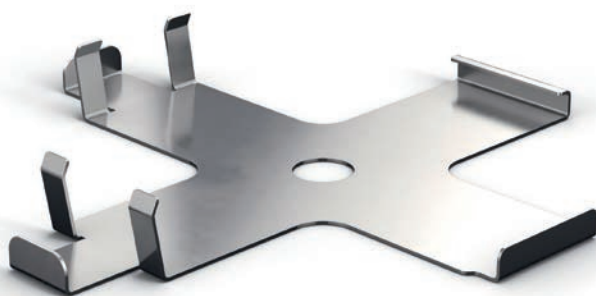

Base

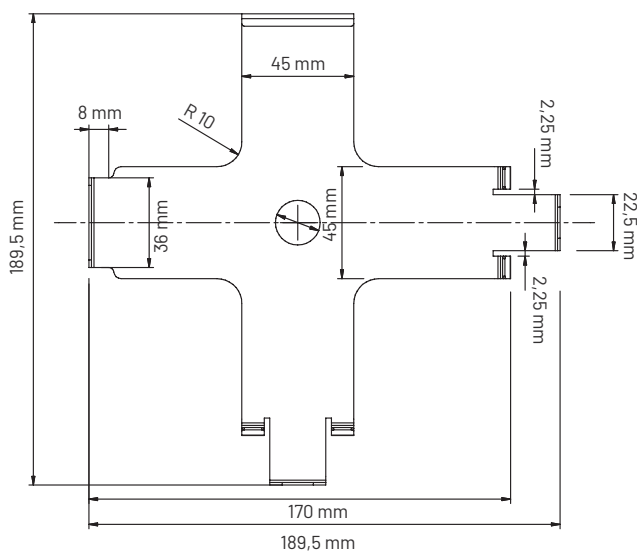
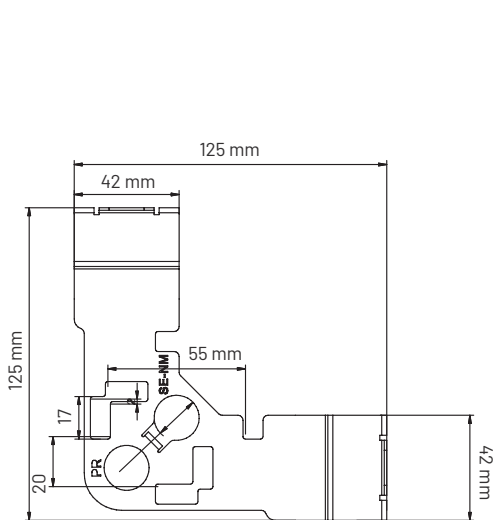

CODE	DESCRIPTION	COMPATIBILITÉ PLOTS	Ø TÊTE PLOTS	ÉPAISSEUR	PIÈCES 
P021000932	Clip tête	PR - SRT - SE - NM - SB	110 mm	20 mm	25
		SRT	150 mm		
P021000912	Clip base	PR - SE - NM - SB	110 mm	20 mm	25
		SRT	150 mm		









**LA COMPATIBILITÉ DES PLOTS
ETERNO IVICA AVEC LES LAMBOURDES
EN ALUMINIUM**

TÊTE S FIXES POUR LAMBOURDE EN ALUMINIUM

TÊTE	PLOT	CODE TÊTE	Ø TÊTE	PIÈCES 
	SRT	E030001010	110 mm	200
		E030001030	150 mm	100
	NM	E034000010	110 mm	200
	NM (à croisillon)	E035093001	130 mm	150
	SB	-	110 mm	-
	Start.T	E003011515 (plot complet)	130 mm	100

TÊTE S BASCULANTES POUR LAMBOURDE EN ALUMINIUM

TÊTE	PLOT	CODE TÊTE	Ø TÊTE	PIÈCES 
	SRT (avec élément basculant)	E030001010 + E030001000	110 mm	200 + 100
		E030001030 + E030001000	150 mm	100 + 100
	PR - SE	E035100010	110 mm	200
	PR - SE (à croisillon)	E035203001	130 mm	150

TÊTES FIXES POUR LAMBOURDE EN BOIS

TÊTE	PLOT	CODE TÊTE	Ø TÊTE	PIÈCES 
	SRT	E030001010	110 mm	200
		E030001030	150 mm	100
	NM	E034000030	110 mm	150
	SB	-	110 mm	-
	Start.T	E003011115	150 mm	100
		E003920100		500
	Vis à croix à bois	Q193000203	Ø 3,5 mm L 20 mm	1000

TÊTES BASCULANTES POUR LAMBOURDE EN BOIS

TÊTE	PLOT	CODE TÊTE	Ø TÊTE	PIÈCES 
	SRT (avec élément basculant)	E030001010 + E030001000	110 mm	200 + 100
		E030001030 + E030001000	150 mm	100 + 100
	PR - SE	E035102530	110 mm	100
	Vis à croix à bois	Q193000203	Ø 3,5 mm L 20 mm	1000



COMMENT CALCULER LA CONSOMATION DE LAMBOURDES, PLOTS ET CLIPS

POUR LA POSE DE DALLES CARRELAGE MONO ET MULTI-FORMAT

1. LA PREMIERE OPERATION EST CELLE DE DEFINIR L'ENTRAXE DES LAMBOURDES ET DES PLOTS

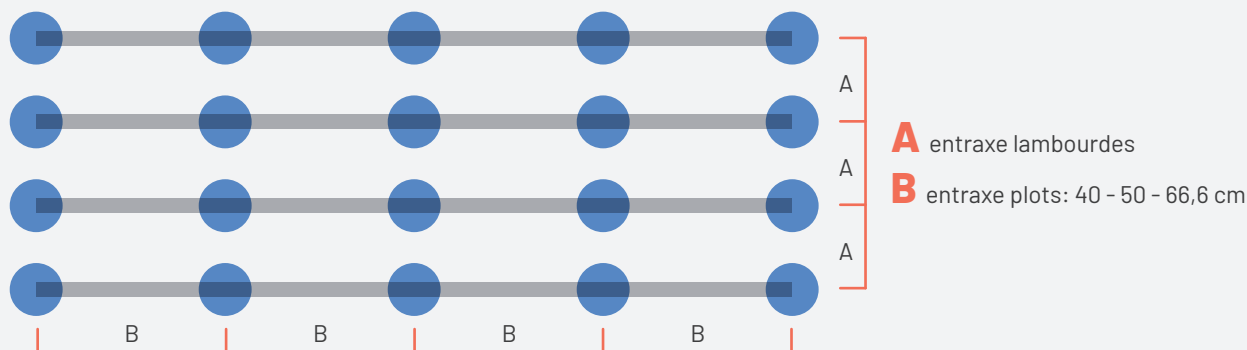

2. APRES AVOIR DEFINI L'ENTRAXE DES LAMBOURDES ON PEUT CALCULER LES MT DE LAMBOURDE À M² ET LE NOMBRE D'ECARTEURS (CLIPS) À CROISILLON AU M²

L'entraxe des lambourdes est calculé sur la base des mesures des dalles de carrelage.

POUTRE EN ALUMINIUM L 200 cm	ENTRAXE LAMBOURDES	DIMENSION DALLE	MT LAMBOURDE AU M ²	N° CLIP À CROISILLON AU M ² (E004000104)
	30 cm	30 x 60 cm 30 x 90 cm	3,33	5,7 3,75
	37,5 cm	75 x 75 cm	2,68	1,8
	40 cm	40 x 60 cm 40 x 80 cm 40 x 120 cm 80 x 80 cm	2,50	4,25 3,2 2,1 1,6
	45 cm	30 x 90 cm 40 x 90 cm 45 x 90 cm 60 x 90 cm 90 x 90 cm	2,25	3,75 2,8 2,5 1,9 1,3
	50 cm	50 x 50 cm	2,00	4
	60 cm	60 x 30 cm 60 x 40 cm 60 x 60 cm 40 x 120 cm 60 x 120 cm 120 x 120 cm	1,67	5,7 4,25 2,78 2,1 1,45 0,8

POUR LA POSE DE DALLES CARRELAGE MONO ET MULTI-FORMAT

3. APRES AVOIR DEFINI L'ENTRAXE DES PLOTS ON PEUT CALCULER LE NOMBRE DE PLOTS AU M²

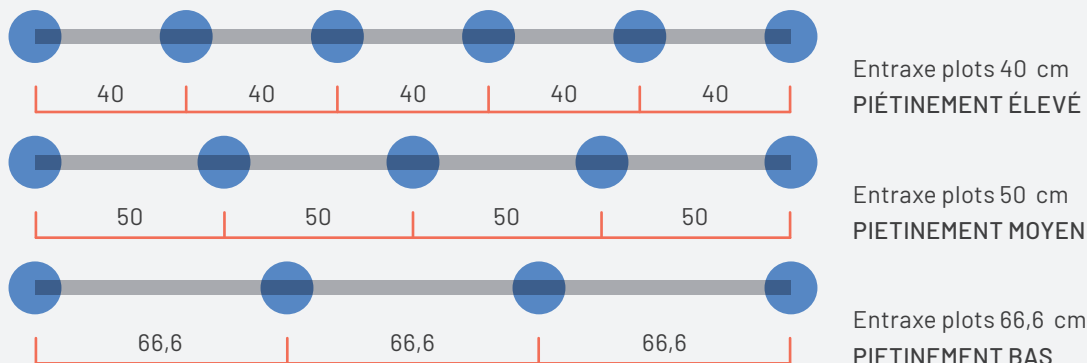

L'entraxe des plots est défini sur la base du type de piétinement du plancher: ÉLEVÉ, MOYEN, BAS.
Le nombre de plots au M² varie selon l'entraxe de la lambourde et de l'entraxe des plots.

ENTRAXE PLOTS	ENTRAXE LAMBOURDE	N° PLOTS AU M ²
40 cm PIÉTINEMENT ÉLEVÉ	30 cm	8,4
	37,5 cm	6,7
	40 cm	6,25
	45 cm	5,6
	50 cm	5
	60 cm	4,25
50 cm PIÉTINEMENT MOYEN	30 cm	6,7
	37,5 cm	5,4
	40 cm	5
	45 cm	4,5
	50 cm	4
	60 cm	3,4
66,6 cm PIÉTINEMENT BAS	30 cm	5
	37,5 cm	4
	40 cm	3,75
	45 cm	3,4
	50 cm	3
	60 cm	2,6

POUR LA POSE DE DALLES CARRELAGE MONO ET MULTI-FORMAT
EXEMPLE AVEC ENTRAXE PLOTS 50 CM

Dalles 30 x 60 cm - Entraxe lambourde 30 cm

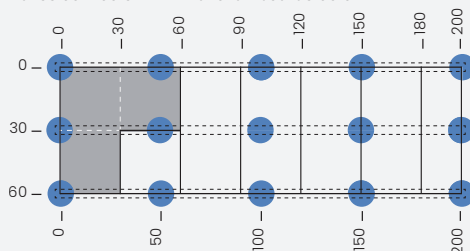

Dalles 30 x 60 cm - Entraxe lambourde 60 cm

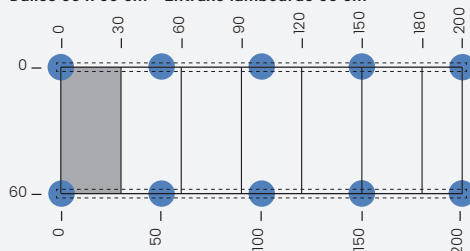

Dalles 30 x 90 cm - Entraxe lambourde 30 cm

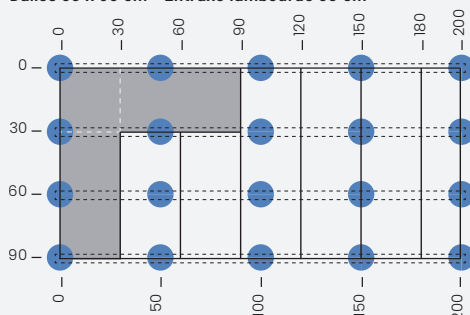

Dalles 60 x 90 cm - Entraxe lambourde 45 cm

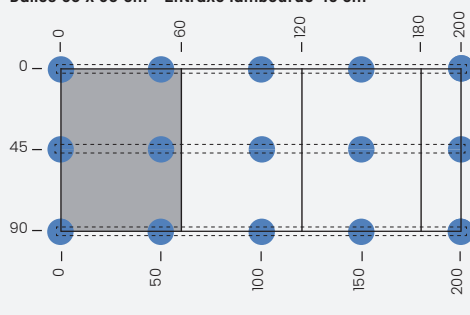

Dalles 30 x 90 cm - Entraxe lambourde 45 cm

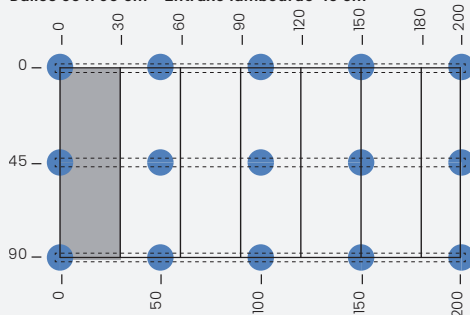

Dalles 60 x 120 cm - Entraxe lambourde 60 cm

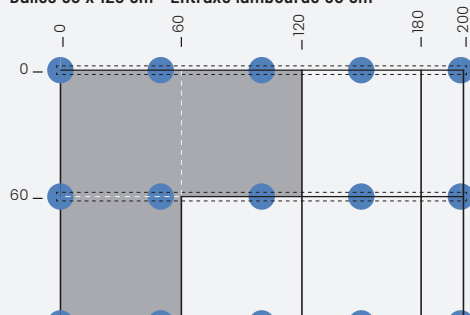

Dalles 45 x 90 cm - Entraxe lambourde 45 cm

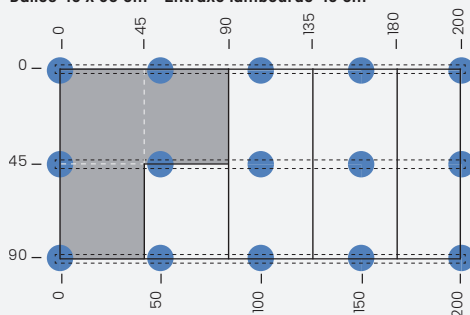

Dalles 40 x 60 cm - Entraxe lambourde 60 cm

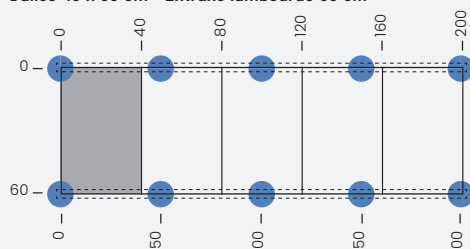

Dalles 40 x 60 cm - Entraxe lambourde 40 cm

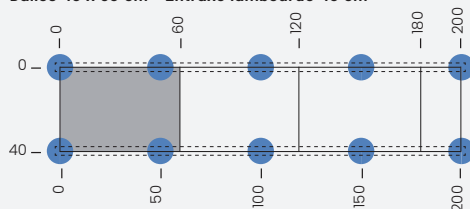

Dalles 40 x 80 cm - Entraxe lambourde 40 cm

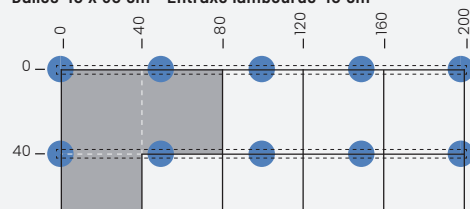

**POUR LA POSE DE DALLES CARRELAGE MONO ET MULTI-FORMAT
EXEMPLE AVEC ENTRAXE PLOTS 50 CM**

Dalles 45 x 90 cm - Entraxe lambourde 45 cm

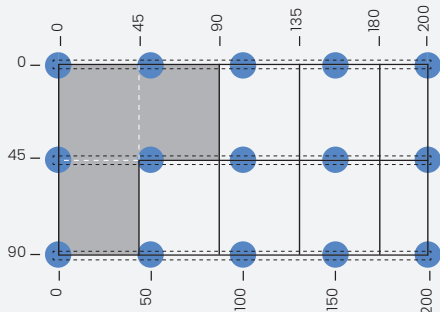

Dalles 50 x 50 cm - Entraxe lambourde 50 cm

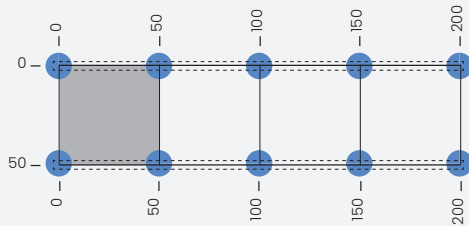

Dalles 40 x 80 cm - Entraxe lambourde 40 cm

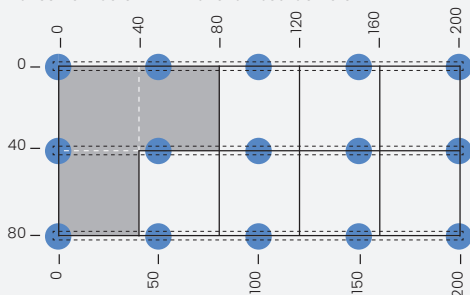

Dalles 60 x 60 cm - Entraxe lambourde 60 cm

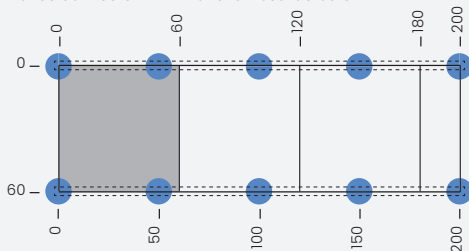

Dalles 40 x 120 cm - Entraxe lambourde 60 cm

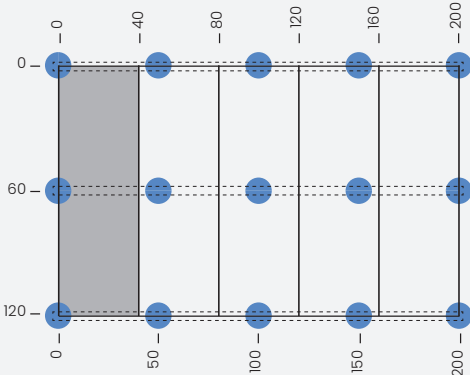

Dalles 75 x 75 cm - Entraxe lambourde 37,5 cm

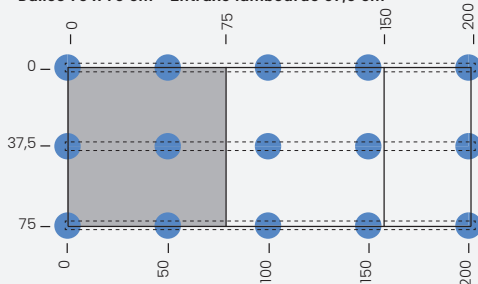

Dalles 80 x 80 cm - Entraxe lambourde 40 cm

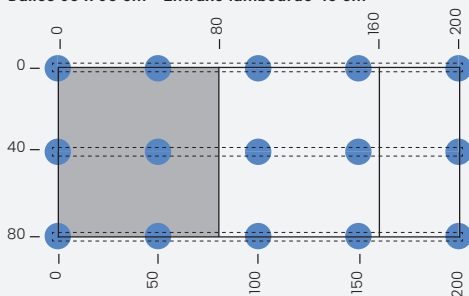

Dalles 120 x 120 cm - Entraxe lambourde 60 cm

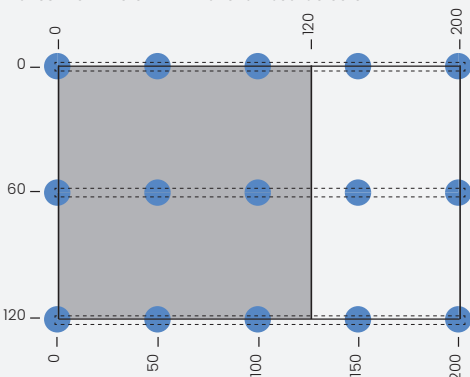

Dalles 90 x 90 cm - Entraxe lambourde 45 cm

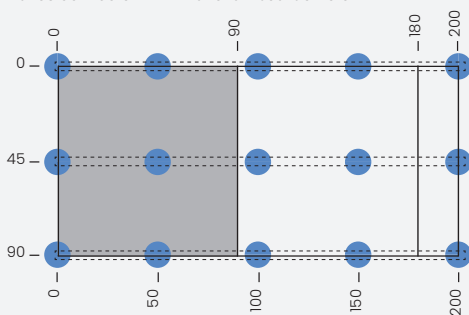

POUR LA POSE DE DALLES CARRELAGE



1. LA PREMIERE OPERATION EST CELLE DE DEFINIR L'ENTRAXE DES LAMBOURDES ET DES PLOTS

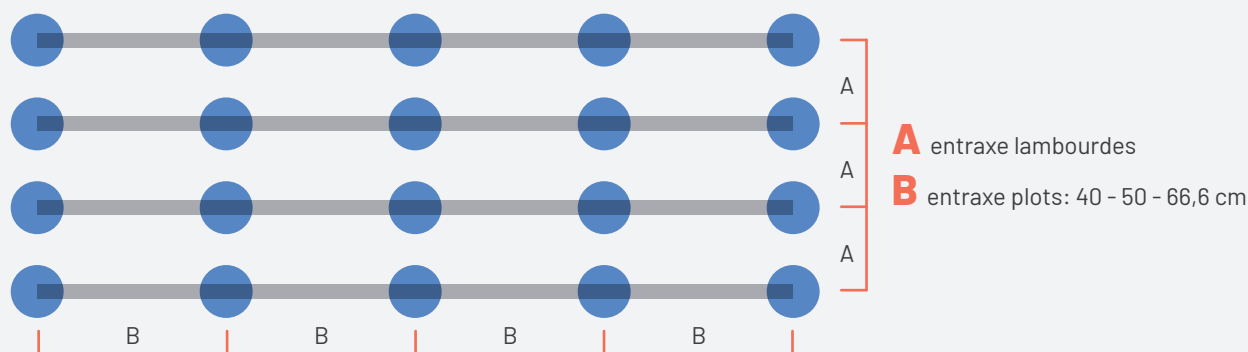

2. APRES AVOIR DEFINI L'ENTRAXE DES LAMBOURDES ON PEUT CALCULER LES MT DE LAMBOURDE AU M² ET LE NOMBRE D'ECARTEURS (CLIP) À CROISILLON AU M²

L'entraxe des lambourdes est calculé sur la base du type de piétinement du plancher: élevé, moyen, bas.

LAMBOURDE EN ALUMINIUM L 200 cm	ENTRAXE LAMBOURDES	DIMENSION DALLE	MT LAMBOURDE AU M ²	N° CLIP À CROISILLON AU M ² (E004000104)
	40 cm PIÉTINEMENT ÉLEVÉ	20 x 120 cm 30 x 120 cm 40 x 120 cm	2,5	4,16 2,8 2,1
	45 cm PIÉTINEMENT MOYEN	30 x 180 cm 40 x 180 cm	2,25	1,85 1,4
	60 cm PIÉTINEMENT BAS	20 x 120 cm 30 x 120 cm 40 x 120 cm 30 x 180 cm 40 x 180 cm	1,67	4,16 2,8 2,1 1,85 1,4

POUR LA POSE DE DALLES CARRELAGE



3. APRES AVOIR DEFINI L'ENTRAXE DES PLOTS ON PEUT CALCULER LE NOMBRE DE PLOTS AU M²

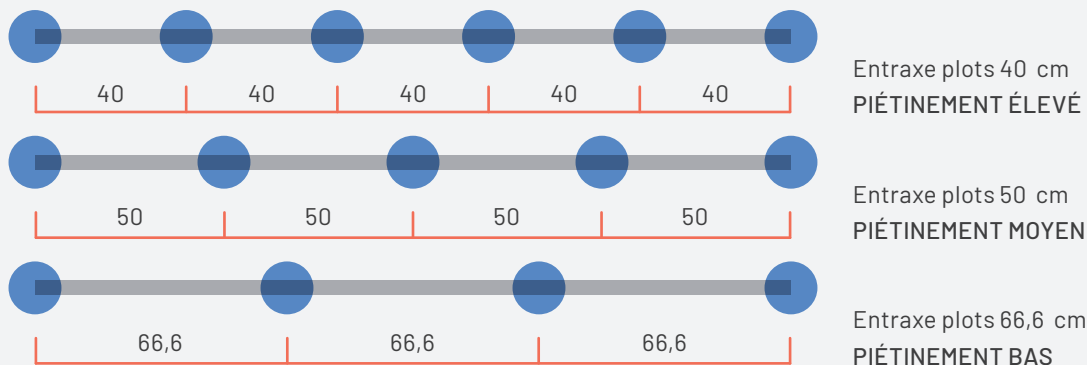

L'entraxe des plots est défini sur la base du type de piétinement du plancher: ÉLEVÉ, MOYEN, BAS.
Le nombre de plots à M² varie selon l'entraxe de la lambourde et de l'entraxe des plots.

ENTRAXE PLOTS	ENTRAXE LAMBOURDE	N° PLOTS AU M ²
40 cm PIÉTINEMENT ÉLEVÉ	40 cm	6,25
	45 cm	5,6
	60 cm	4,25
50 cm PIÉTINEMENT MOYEN	40 cm	5
	45 cm	4,5
	60 cm	3,4
66,6 cm PIÉTINEMENT BAS	40 cm	3,75
	45 cm	3,4
	60 cm	2,6



Clip rapide à ailettes 4 mm h 12 mm.

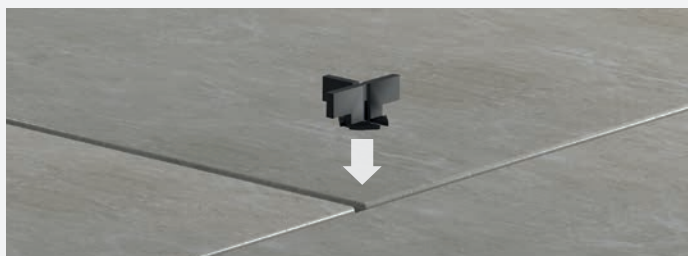

**POUR LA POSE DE DALLES CARRELAGE
EXEMPLE AVEC ENTRAXE PLOTS 50 CM**



Dalles 20 x 120 cm - Entraxe lambourde 40 cm

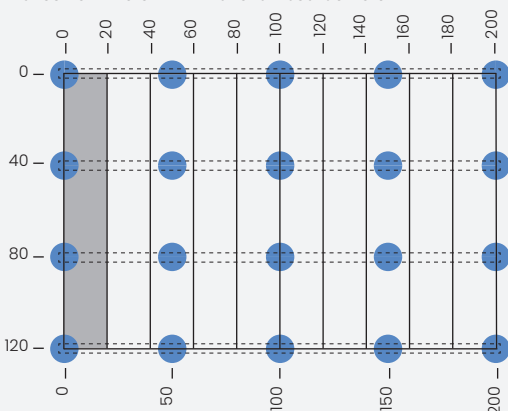

Dalles 20 x 120 cm - Entraxe lambourde 60 cm

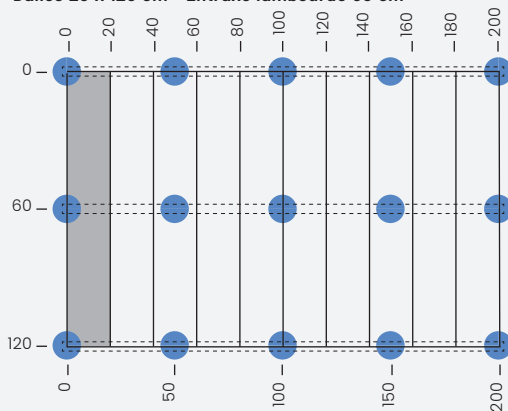

Dalles 30 x 120 cm - Interasse travetto 40 cm

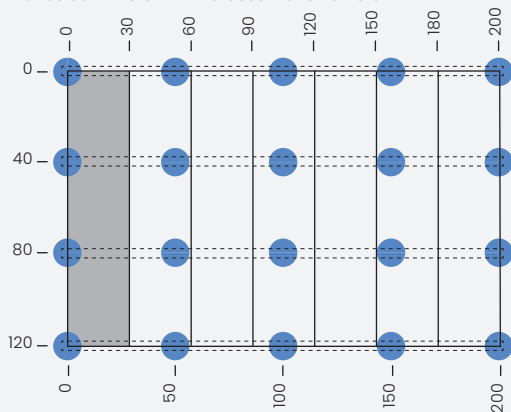

Dalles 30 x 120 cm - Entraxe lambourde 60 cm

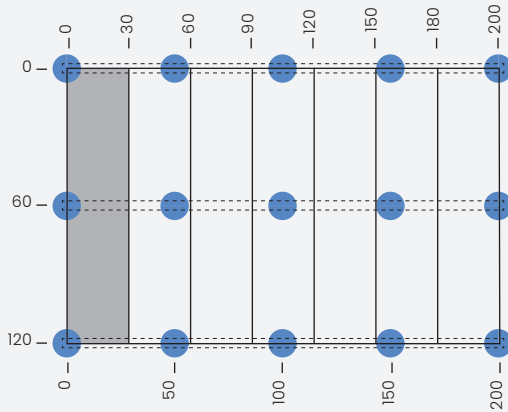

Dalles 40 x 120 cm - Entraxe lambourde 40 cm

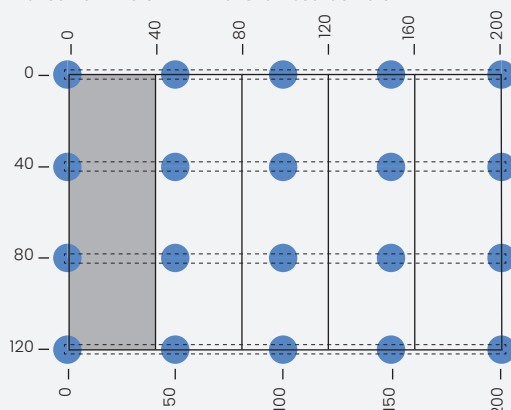

Dalles 40 x 120 cm - Entraxe lambourde 60 cm

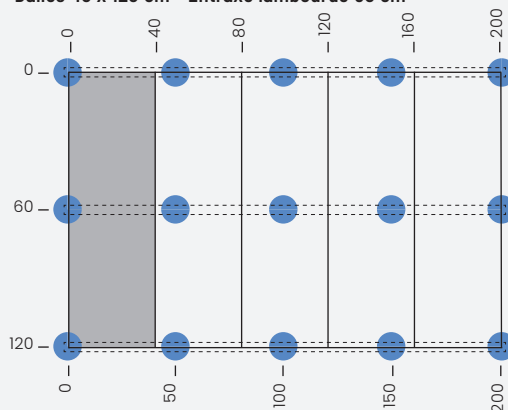

**POUR LA POSE DE DALLES CARRELAGE
EXEMPLE AVEC ENTRAXE PLOTS 50 CM**



Dalles 30 x 180 cm - Entraxe lambourde 45 cm

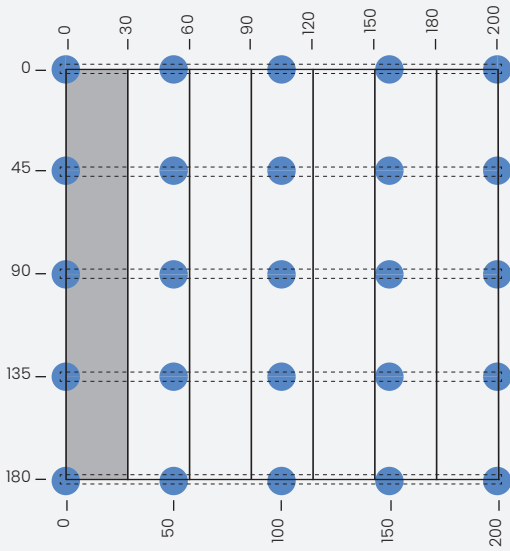

Dalles 30 x 180 cm - Entraxe lambourde 60 cm

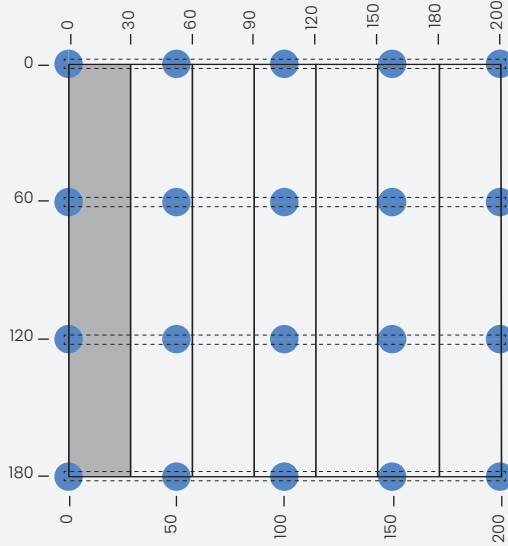

Dalles 40 x 180 cm - Entraxe lambourde 45 cm

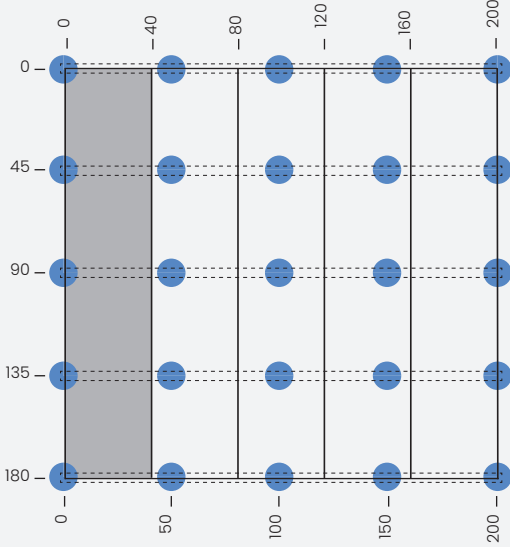

Dalles 40 x 180 cm - Entraxe lambourde 60 cm

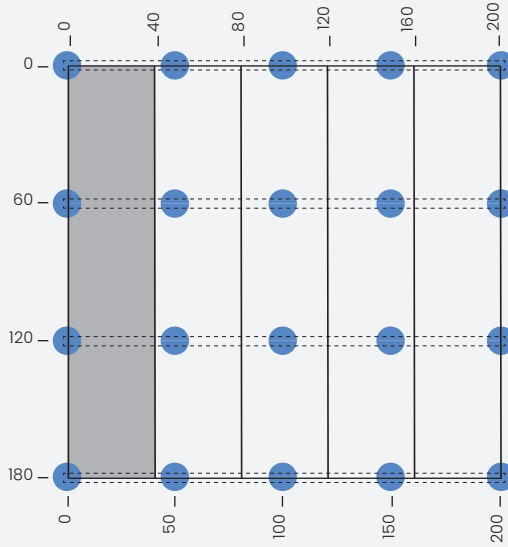

POUR LA POSE DE LATTES EN BOIS/WPC



1. LA PREMIERE OPERATION EST CELLE DE DEFINIR L'ENTRAXE DES LAMBOURDES ET DES PLOTS

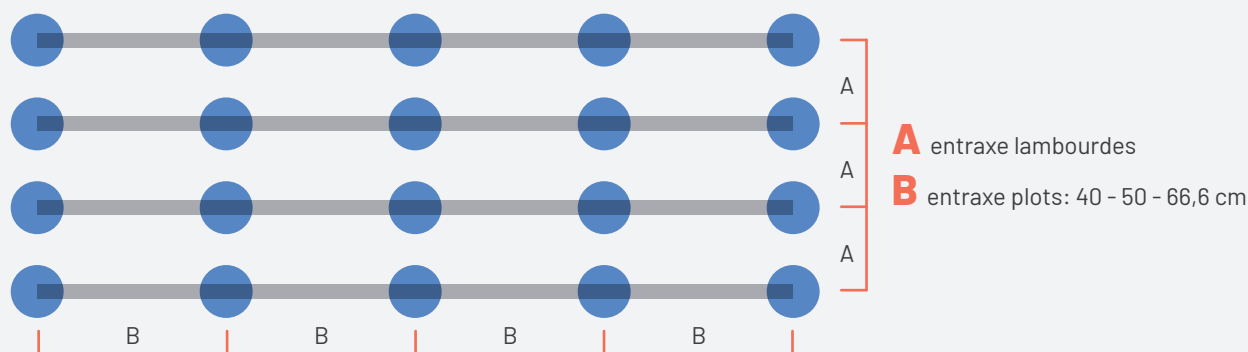

2. APRES AVOIR DEFINI L'ENTRAXE DES LAMBOURDES ON PEUT CALCULER LES MT DE LAMBOURDE AU M² ET LE NOMBRE DE CLIPS AU M²

L'entraxe des lambourdes est calculé sur la base du type de piétinement du plancher: élevé, moyen, bas.

LAMBOURDE EN ALUMINIUM L 200 cm	ENTRAXE LAMBOURDES *	DIMENSION LATTE	MT LAMBOURDE À M ²	N° CLIP SIMPLE MT LAMBOURDE	N° CLIP DOUBLE MT LAMBOURDE
	30 cm PIÉTINEMENT ÉLEVÉ	Longueur: da 95 a 225 cm Largeur: da 9 a 14,5 cm Épaisseur: da 1,9 a 3 cm	3,3	A	B
	40 cm PIÉTINEMENT MOYEN	Longueur: da 95 a 225 cm Largeur: da 9 a 14,5 cm Épaisseur: da 1,9 a 3 cm	2,50	A	B
	50 cm PIÉTINEMENT BAS	Longueur: da 95 a 225 cm Largeur: da 9 a 14,5 cm Épaisseur: da 1,9 a 3 cm	2,00	A	B

* Nous conseillons de vérifier toujours l'entraxe de la lambourde avec le producteur des lattes en bois.

A 1 mt (1000 mm: largeur latte x2
Ex: 1000 mm : 140 mm = 7,14 x 2 = 14,28 clip/mt lambourde

B 1 mt (1000 mm: largeur latte
Ex: 1000 mm : 140 mm = 7,14 clip/mt lambourde

POUR LA POSE DE LATTES E BOIS/WPC



3. APRES AVOIR DEFINI L'ENTRAXE DES PLOTS ON PEUT CALCULER LE NOMBRE DE PLOTS AU M²

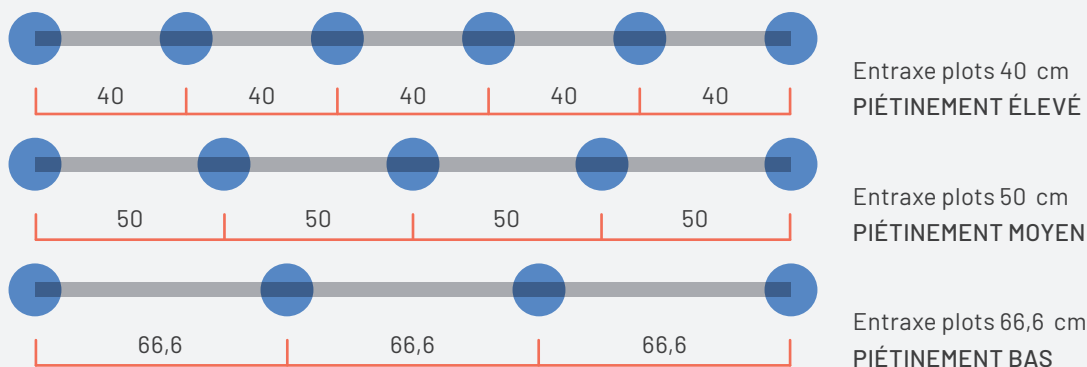

L'entraxe des plots est défini sur la base du type de piétinement du plancher: ÉLEVÉ, MOYEN, BAS.
Le nombre de plots à M2 varie selon l'entraxe de la lambourde et de l'entraxe des plots.

ENTRAXE PLOTS	ENTRAXE LAMBOURDE	N° PLOTS AU M ²
40 cm PIÉTINEMENT ÉLEVÉ	30 cm	8,4
	40 cm	6,25
	50 cm	5
50 cm PIÉTINEMENT MOYEN	30 cm	6,7
	40 cm	5
	50 cm	4
66,6 cm PIÉTINEMENT BAS	30 cm	5
	40 cm	3,75
	50 cm	3









MADE IN ITALY



ETERNO IVICA SRL

via Austria, 25/E
35127 Padova - Italy

ITA +39 049 8530101

EXP +39 049 8530102

FAX +39 049 8530111

eternoivica@eternoivica.com

www.eternoivica.com



MADE IN ITALY

eternoivica

ETERNO IVICA SRL

via Austria, 25/E
35127 Padova - Italy

ITA +39 049 8530101
EXP +39 049 8530102
FAX +39 049 8530111

eternoivica@eternoivica.com
www.eternoivica.com